



PROFESSIONAL

SINGING ROCK was founded in 1992. During 27 years of its existence, Singing Rock has established itself as a professional and innovative producer and supplier of personal fall protective equipment. Nowadays SINGING ROCK is one of the world leaders on the market of professional protective equipment for work at height, military and rescue. All of the high-performance and innovative products are developed and produced in Czech Republic, Europe. Our products are certified and fully comply with the international industrial safety standards. Our products are innovative, modern and easy to use, with great strength and with maximum comfort.

www.singingrock.com



Fully adjustable harness:

- for a rope access with wide padded
- waist belt
- leg loops
- shoulder straps

Suitable also for work positioning, fall arrest and work restraint situations.

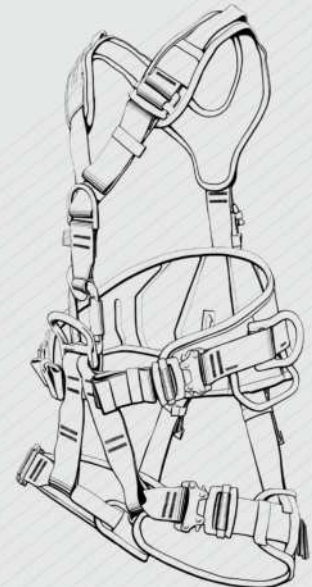

INNOVATION

It is not necessary to talk too much about the innovation as it is inherently present in all our products.

TESTING

Meeting minimum requirements is obvious – but we go further by performing tests to simulate all kind of usage as the basis for further development.

TECHNOLOGY

Appropriate technology and tools are essential to produce first-class products.



KNOWLEDGE & EXPERIENCE

Our products and techniques are thoroughly validated in our own testing and training centers. We are pleased to share all this with our customers – you get a complex solution.

INVOLVEMENT

We are climbers and we love climbing. Enthusiasm drives our innovations and improvements.

PERFORMANCE

Do your job efficiently, safely and comfortably – we are here to give you the tools to do this. Enjoy your work.



eocca
european outdoor
conservation association

TRADITION & STABILITY

We draw on 27 years of our own experience and we are proudly inspired by vast knowledge and experience of climbers from our region.

EFFICIENCY

We run lean management system with horizontal organization structure. Thanks to this we are able to react immediately and customize our products and services for your specific needs.

ENVIRONMENT

We bear the responsibility to keep our planet green and to preserve its riches for our kids. SINGING ROCK is member of the European Outdoor Conservation Association.





SINGING ROCK produce harnesses which are very comfortable, simple to use and suitable for every working situation for workers at height. Thanks to the innovated technologies and smart solutions, SINGING ROCK can offer a full range of safety harnesses covering all areas of working applications. SINGING ROCK harnesses are exclusively manufactured in Czech Republic.

HARNESSES

- ROPE ACCESS
- FALL ARREST
- FULL BODY
- CHEST
- SIT HARNESSES
- ARBORICULTURE
- RESCUE
- ACCESSORIES





ROCK & LOCK

patented smart buckle system

Easy to lock and open: Only a small amount of finger pressure is needed to lock and to open.

- Fast lace-through: Make the loop, put it through the buckle frame, hook the loop on the cross bar and tighten. It's as easy as that.
- Smart function: Rock&Lock allows you to put on your harness very quickly
- Double safety: Webbing cannot slip through Rock&Lock due to a safety loop at the end of the webbing Spontaneous opening of Rock&Lock is virtually impossible.
- Lightweight and extra strong.
- Excellent operation in all-season conditions: Operation guaranteed even when webbing is wet or frozen.



EASY-LOCK BUCKLE

smooth adjusting

Unique buckle with a sliding captive bar matches strict American standards (ANSI, CSA). Its minimum strength is 17.2 kN. No webbing slippage in a buckle. Its construction ensures longtime operation and efficiency (easy releasing and fastening even when dirty and tough webbing). Corrosion resistance is tested by spraying in a salty chamber for a period of 48 hours.



SPEED BUCKLE

1 second buckle

SINGING ROCK SPEED buckle is the side quick release buckle.

- Easy operation
- Durable and adjustable
- Made from steel
- Matches strict American standard ANSI
- Impossible opening under the loading
- Impossible to lock when the strap is twisted
- Strap width up to 45 mm
- Black coated
- Strength 18 kN



Chimney power washing, Czech republic Photo: Petr Piechowicz

SINGING ROCK HARNESSES INNOVATIONS

SUPER COMFORTABLE WIDE WAIST BELT PADDING PROVIDES MAXIMUM COMFORT WHEN WORKING AT HEIGHTS

CHEST ASCENDER SMART FIXATION SYSTEM WITH PLASTIC COVER ON OZONE CARABINER INCREASING THE DURABILITY OF THE WEBBING

ANATOMIC LEG LOOPS AND WAIST BELT ARE COVERED WITH STRONG PES FABRIC PROVIDING HIGH ABRASION RESISTANCE

SHOULDER CONNECTION FOR CONFINED SPACE RESCUE

FIXED WEBBING IN A REAR ADJUSTMENT BUCKLE TO AVOID WEBBING ROTATION

REFLECTING STRAP AND PRINTING ON THE WAIST BELT INCREASE THE VISIBILITY IN DARK WORKING CONDITIONS

STRENGTH WEBBING ON THE WAIST BELT IS STITCHED IN THE WAY THAT AT NORMAL WORKING SITUATION THE BODY WEIGHT IS ABSORBED BY THE PADDING ONLY

4 ERGONOMIC BRAIDED GEAR LOOPS WITH A BEARING CAPACITY 15 kg

ADDITIONAL LOOPS ON THE LEG LOOPS AND WAIST BELT WITH A BEARING CAPACITY OF 5kg FOR BETTER GEAR ORIENTATION

ALL STEEL COMPONENTS FINISHED WITH ED COATING FOR HIGHER CORROSION RESISTANCE

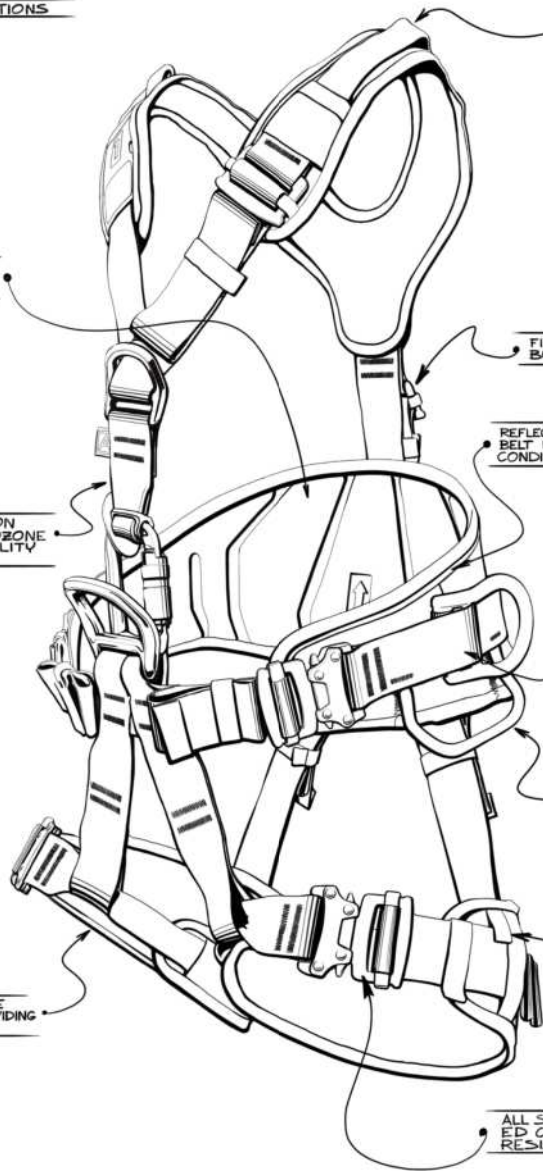

These icons will help you to choose the proper harness regarding the most common and most suitable use:



rope access



rescue



work restraint



fall arrest



intervention



rope park



tree care

EXPERT 3D / SPEED 

 W0079DR
 black version – W0079DB

Fully adjustable harness for a rope access with wide padded waist belt, leg loops and shoulder straps. Suitable also for work positioning, fall arrest and work restraint situations.

- shoulder straps can be totally removed and the harness can be used as a sit harness only
- super comfortable wide waist belt padding provides maximum comfort when working at height
- strength webbing on the waist belt is stitched in the way that at normal working situation the body weight is absorbed by the padding only
- reflective strap and printing on the waist belt and shoulder padding increase the visibility in dark working conditions
- anatomic leg loops and waist belt are covered with strong PES fabric providing high abrasion resistance
- SPEED buckles enable fluent and fast adjustment to fit a user's body
- OZONE triple lock carabiner used for connection of shoulder straps to the main point to increase the space for chest ascender attachment
- chest ascender smart fixation system with plastic cover on the Ozone carabiner increasing the durability of the webbing
- shoulder straps and leg loops are independently adjustable
- narrowed padding and webbing on the shoulder straps in a neck area enhance a comfortable work
- front and back attachment points for fall-arrest according to EN 361 marked with additional "A" marking
- rear lower attachment point according to EN 813
- flat rear attachment point does not bear on users back when carrying backpack or breathing apparatus
- front lower attachment point for descender placement or work positioning according to EN 813, EN 358
- 2 side attachment points for work positioning according to EN 358
- heavier items up to 35 kg can be attached to the webbing on the waist belt
- all steel components finished with E coating for higher corrosion resistance
- 4 ergonomic braided gear loops with a bearing capacity 5 kg
- additional loops on the waist belt and leg loops with a bearing capacity of 5 kg offer additional space for the gear and better gear orientation
- wide elastic band on left shoulder strap for the gear attachment (f.e. transmitter)
- slots on the waist belt for PORTER tool holder to carry your industrial tools
- identification and methodical label

Size: S, M/L, XL

Weight: (M/L) 2415 g • 85.19 oz

€ 1019 • EN 358 • EN 813 • EN 361 • EN 1497



EXPERT 3D / STANDARD W0078DR
black version – W0078DB

- standard easy-lock buckles enable smooth adjustment
- super comfortable wide waist belt padding provides maximum comfort even during prolonged suspension

Size: S, M/L, XL
 Weight: (M/L) 2110 g • 74.43 oz
 CE 1019 • EN 358 • EN 813 • EN 361 • EN 1497

EXPERT 3D / SPEED STEEL 

W0080DR



- the harness is made in accordance with strict American standards (NFPA, ANSI)

Size: S, M/L, XL
 Weight: (M/L) 2685 g • 94.71 oz
 CE 1019 • EN 358 • EN 813 • EN 361 • EN 1497
 NFPA Class III • ANSI Z359.1



EXPERT III

 standard – W0078BR
 standard black version – W0078BB

 speed – W0079BR
 speed black version – W0079BB
 speed steel – W0080BR

EXPERT III standard

Fully adjustable harness for a rope access with padded waist belt, leg loops and shoulder straps. Suitable for work positioning, fall arrest and work restraint situations. The Expert III harness is modular to fit the user's body.

- shoulder straps can be totally removed and the harness can be used as a sit harness only
- OZONE triple lock used for connection of shoulder straps to the main point to increase the space for THE chest ascender attachment
- chest ascender smart fixation system with plastic cover on the Ozone carabiner increasing the durability of the webbing
- anatomic waist belt, leg loops and shoulder straps padding insure enough comfort
- shoulders straps and leg loops are independently adjustable
- narrowed padding and webbing on the shoulder straps in a neck area enhance a comfortable work
- front and back attachment points for fall-arrest according to EN 361 marked with additional "A" marking
- front lower attachment point for descender placement or work positioning according to EN 813, EN 358
- rear lower attachment point according to EN 813
- 2 side attachment points for work positioning according to EN 358
- all steel components finished with E coating for higher corrosion resistance
- 2 braided gear loops with a bearing capacity of 5 kg
- additional loops with a bearing capacity of 5 kg offer additional space for the gear and better gear orientation
- identification and methodical label

Size: S, M/L, XL

SPEED:

 Weight: (M/L) 2450 g (± 15 g) • 86.42 oz (±0,5 oz)
 € 1019 • EN 358 • EN 813 • EN 361

SPEED STEEL:

 Weight: (M/L) 2665 g (± 15 g) • 94 oz (± 0.5 oz)
 € 1019 • EN 358 • EN 813 • EN 361
 NFPA Class III

STANDARD:

 Weight: (M/L) 2155 g (± 15 g) • 76.02 oz (±0,5 oz)
 € 1019 • EN 358 • EN 813 • EN 361

EXPERT III speed



PROFI WORKER 3D / SPEED W0082DR
black version – W0082DB

Fully adjustable harness for a rope access with wide padded waist belt, leg loops and shoulder straps. Suitable also for work positioning, fall arrest and work restraint situation.

- super comfortable wide waist belt padding provides maximum comfort when working at height
- strength webbing on the waist belt is stitched in the way that at normal working situation the body weight is absorbed by the padding only
- reflective strap and printing on the waist belt and shoulder padding increase the visibility in dark working conditions
- anatomic leg loops and waist belt are covered with strong PES fabric providing high abrasion resistance
- SPEED buckles enable fluent and fast adjustment to fit a user's body
- narrowed padding and webbing on the shoulder straps in a neck area enhance a comfortable work
- leg loops connection straps made from durable PES webbing for better abrasion resistance
- front and back attachment points for fall-arrest according to EN 361 marked with additional „A“ marking
- rear lower attachment point according to EN 813
- flat rear attachment point does not bear on users back when carrying backpack or breathing apparatus
- front lower attachment point for descender placement or work positioning according to EN 813, EN 358
- 2 side attachment points for work positioning according to EN 358
- heavier items up to 35 kg can be attached to the webbing on the waist belt
- 4 ergonomic braided gear loops with a bearing capacity 5 kg
- additional loops on the waist belt and leg loops with a bearing capacity of 5 kg offer additional space for the gear and better gear orientation
- wide elastic band on left shoulder strap for the gear attachment (f.e. transmitter)
- slots on the waist belt for PORTER tool holder to carry your industrial tools
- identification and methodical label

Size: S, M/L, XL •

Weight: (M/L) 2075 g • 73.19 oz

CE 1019 • EN 358 • EN 813 • EN 361 • EN 1497



PROFI WORKER 3D / STANDARD 

 W0081DR
 black version – W0081DB

Fully adjustable harness for a rope access with wide padded waist belt, leg loops and shoulder straps. Also suitable for work positioning, descent, ascent and rescue situations

- standard easy-lock buckles enable smooth adjustment
- super comfortable wide waist belt padding provides maximum comfort even during prolonged suspension

Size: S, M/L, XL •
 Weight: (M/L) 1777 g • 62.68 oz
 € 1019 • EN 358 • EN 813 • EN 361 • EN 1497

 PROFI WORKER III 

 speed – W0082BR
 standard – W0081BR

Fully adjustable harness for a rope access with padded waist belt, leg loops and shoulder straps. Suitable for work positioning, fall arrest and work restraint situation.

- anatomic waist belt, leg loops and shoulder straps padding insure enough comfort
- narrowed padding and webbing on the shoulder straps in a neck area enhance a comfortable work
- leg loops connection straps made from durable PES webbing for better abrasion resistance
- front and back attachment points for fall-arrest according to EN 361 marked with additional „A“ marking
- front lower attachment point for descender placement or work positioning according to EN 813, EN 358
- rear lower attachment point according to EN 813
- 2 side attachment points for work positioning according to EN 358
- 2 braided gear loops with a bearing capacity of 5 kg
- additional loops with a bearing capacity of 5 kg offer additional space for the gear and better gear orientation
- identification and methodical label

Size: S, M/L, XL

SPEED:
 Weight: (M/L) 1960 g (±15 g) • 69.14 oz (±0.5 oz)
 € 1019 • EN 358 • EN 813 • EN 361

STANDARD:
 Weight: (M/L) 1650 g (±15 g) • 58.20 oz (±0.5 oz)
 € 1019 • EN 358 • EN 813 • EN 361



TECHNIC STANDARD

W0063BB



Fully adjustable work positioning and fall arrest harness with easy-lock buckles.

- an attachment point for work in hanging position, rapelling according to EN 813
- steel positioning points according to EN 358 are placed symmetrically. Steel D-rings are flat and settled on a padding
- easy-lock buckles enable fluent adjustment to fit the user's body
- 2 braided gear loops with a bearing capacity of 5 kg
- slots designed for a secure hanging of expensive equipment (such as power saw, drilling machine,..)
- identification and methodical label
- slide buckle intended for chest ascender fastening
- chest attachment point according to EN 361
- dorsal attachment point according to EN 361

Size: S, M/L, XL

Weight: (M/L) 1620 g (±15 g) • 57.14 oz (±0.5 oz)

CE 1019 • EN 358 • EN 813 • EN 361



TECHNIC SPEED STEEL

W0064BB



Fully adjustable full body harness for work positioning and fall arrest with the steel components and SPEED buckles.

- innovated steel SPEED buckles enable fluent and fast adjustment to fit the user's body
- the harness is made in accordance with strict American standards (NFPA, ANSI)
- steel positioning points according to EN 358 are placed symmetrically. Steel D-rings are flat and settled on a padding

Size: S, M/L, XL

Weight: (M/L) 2450 g (±15 g) • 86.42 oz (±0.5 oz)

CE 1019 • EN 358 • EN 813 • EN 361

NFPA Class III • ANSI Z359.1



ROOF MASTER

W0091BY



Lightweight and fully adjustable full body harness. Most suitable for work on inclined areas and roofs. The unique Singing Rock MOTION SYSTEM gives the user freedom of movement without being restricted by working rope or fall arrest system. An ideal solution for working at heights where the precise positioning and free movement are important.

- the MOTION SYSTEM ensures precise positioning and maximum comfort of movement during work
- during the fall arrest to the back red textile attachment point EN 361, the MOTION SYSTEM efficiently splits the energy of the fall to the particular body parts
- the front fall arrest point EN 361 (the red light alloy D-ring) is lower than usual and makes a full use of the advantages of the front part of the MOTION SYSTEM
- thanks to the MOTION SYSTEM it is also possible to use this attachment point for work positioning, without limiting the user's movement. The user is thus able to work without any problems, while being at the same time safely attached to the fall arrest attachment point and protected against the possibility of fall
- the red D-ring can also be used as EN 813 because it functions as an extension of the whole mobile bridge
- also usable for rope access the harness can be easily supplemented with the CAM CLEAN chest ascender
- easy adjustment of the waist belt and comfort during putting the harness on are ensured by two buckles (STANDARD on the right side and SPEED on the left side)
- the side textile loops for the work positioning EN 358 are highlighted by red sewing and can be used for two carabiners at most
- the 3D waist belt is equipped with a rubberized strength fabric with number of attachment holes through which the reep cord can be drawn to create different kinds of loops, or to which the additional carabiners for the tool bag can be attached (the maximum bearing capacity of each hole is 10 kg)
- the belt is also equipped with two standard grey textile loops with bearing capacity of 5 kg
- the ring-shaped leg loops are lightweight, yet very comfortable, their size can be easily adjusted with the steel buckles and they are connected to the work positioning belt by an elastic strap at the back
- a neoprene pocket for small objects on the right leg loop
- reflective printing on the waist belt increases the visibility of the safety harness

Weight: (M/L) 1570 g • 55,38 oz

Size: S, M/L, XL

CE 1019 • EN 358 • EN 813 • EN 361



SEAMASTER 3D STAINLESS STEEL 

W0074DR



Fully adjustable harness for rope access with a padded wide waist belt, leg loops and shoulder straps. Suitable for work positioning, fall arrest and work restraint situations. This harness is specially intended for workers at offshore oil platforms.

- stainless steel components make the harness ultimate choice for offshore operations
- padded waist belt, shoulder straps and leg loops
- wide waist belt provides maximum comfort when working at height
- narrowed padding and webbing on the shoulder straps in a neck area enhance comfortable work
- reflective printing on the waist belt increases the visibility in dark working conditions
- front attachment point for fall-arrest according to EN 361
- front lower attachment point for descender placement or work positioning according to EN 813
- side attachment points for work positioning according to EN 358
- 3 braided gear loops with a bearing capacity of 5 kg
- heavier items up to 35 kg can be attached to the webbing on the waist belt
- additional loops with a bearing capacity of 5 kg offer additional space for the gear and better gear orientation
- combination of standard and SPEED buckles enable fluent and fast adjustment to fit the users body
- special construction of central loop provides excellent comfort when hanging in the harness
- easy fixing CAM CLEAN ascender in vertical position is provided by stitched strap between lower front attachment point and front tie-in point

Weight: 1870 g [size M/L] • 66 oz

Size: S, M/L, XL

CE 1019 • EN 361 • EN 358 • EN 813



Oil platform, Photo: archive Singing Rock

ANTISHOCK I 

W0086B0



Full body harness for rope access, work positioning, fall arrest. The Antishock I is the perfect solution for work at height in explosive atmospheres. It is particularly suitable for energetics, petrochemical and mining environments.

- all metal and alloy parts are overmolded with colored plastic with an electrical puncture resistance of 10 kV and antistatic finishing
- shoulder attachment points for confined space rescue according to EN 1497
- double buckles made in accordance with strict American standards (ANSI, NFPA). Its minimum strength is 17.8 kN.
- front and back fall arrest attachment points according to EN 361 meets American standards (ANSI, NFPA). Marked with additional „A“ marking
- 2 side attachment points for work positioning according to EN 358
- Front lower attachment point for descender placement or work positioning according to EN 813

- anatomic waist belt, leg loops and shoulder straps padding ensure enough comfort
- narrowed padding and webbing on the shoulder straps in a neck area enhance a comfortable work
- chest ascender smart fixation system
- chest ascender maillon slot (recommended maillon big D, EN 362)
- 2 large braided gear loops with a bearing capacity of 5 kg
- identification and methodical label. To prolong its lifetime is advised to hide this label under the webbing.
- name tag for easier recognition of the harness

Size: S, M/L, XL

Weight (M/L): 2100g • 74.1 oz

 CE 1019 • EN 358 • EN 813 • EN361 • EN 1497
 ANSI Z359.1 • NFPA Class III

 TARZAN 

W0050



Fully adjustable full body harness intended for rope courses and adventure parks.

- attachment point for work in hanging position, rappelling according to EN 813.
- anatomic waist belt and leg loops padding
- speed buckle connecting shoulder straps with waist belt. Increased comfort when putting the harness on.
- buckle with a captive bar matches strict American standards (ANSI). Its minimum strength is 17.2 kN. No webbing slippage in a buckle. Its construction ensures longtime operation and efficiency (easy releasing and fastening even when dirty and tough webbing).
- Shoulder webbing has different colour for easy manipulation
- Left leg loops with red colour inside helps to put the harness on
- Different colour of rear plate for each size.
- Dorsal attachment point according EN 361. Steel D-ring with a bearing capacity of 15 kN. This D-ring is flat and settled on a padding.
- Webbing strap stitched in the buckle simplify handling with buckle

Size: XS – S, M – XL

Weight: 1530 g (M – XL) ±15 g • 54 oz

CE 1019 • EN 813 • EN 361



TARZAN ECONOMIC 

W0059BR

**Fully adjustable full body harness intended for rope courses and adventure parks.**

- front attachment point for belaying and rappelling according to EN 12277 type C
- waist belt and leg loops without the padding enables to put a harness to every person
- rear steel D-ring with a bearing capacity of 15 kN according EN 361
- shoulder straps, waist belt and leg loops are easily adjustable with Easy Lock buckles
- all steel components are finished with E coating technology for higher corrosion resistance
- left leg loop with red colour helps to put the harness on
- webbing strap stitched in the buckle simplify handling with a buckle
- dorsal plastic plate with different color according the size of the harness (S – yellow, UNI – red)

Size: S (110 – 150 cm), UNI (150 – 200 cm)

Weight: 1050 g • 34 oz (UNI)

CE 1019 • EN 12277 • EN 361

ROPEDANCER II 

W0087BY

**Fully adjustable full body harness with various attachment points intended for rope courses and adventure parks**

- easy to put on and off,
- easy to adjust, thanks to 5 double buckles and 1 SPEED buckle
- bright color front lower attachment point for rappelling and belaying according to EN 813
- waist belt in different (black) color for better orientation within the harness
- front and rear attachment points according to EN 361 for fall-arrest
- 2 gear loops with a bearing capacity of 5 kg
- max. rated load of the harness 150 kg
- different color of the rear triangle for each size
- suitable also for working at height

Weight: (S/M/L) 1195 g • 42.15 oz

CE 1019 • EN 361 • EN 813



BODY II STANDARD 

 W0068BR
 black version – W0068BB

Fully adjustable fall-arrest harness with various attachment points.

- two fall-arrest attachment points according to EN 361
- harness is compact and light-weight, thus suitable for horizontal or inclined space. It also allows temporary hanging in.
- intended for working in places with the risk of fall
- flat rear attachment point does not affect comfort when wearing the backpack or breathing apparatus
- shoulder and leg loops webbings are colour distinguished for easy manipulation
- webbing stitched in the buckle simplify handling
- two gear loops with max. load 5 kg
- easy to adjust, easy to put on and off
- suitable also for rope courses and adventure parks
- different colour of rear triangle for each size (S/M/L- grey, XL/XXL- yellow)
- 2 sizes fit whole size range from 150 to 210 cm

 Size: S/M/L, XL/XXL, XXXL
 Weight: 1025 g • 36.16 oz (size S/M/L)
 € 1019 • EN 361

BODY II SPEED 

 W0071BY
 black version – W0071BB

Fully adjustable fall-arrest harness with various attachment points.

- version with Speed buckles on the leg loops enables easy putting the harness on
- easy to adjust, easy to put on and off
- webbing stitched in the buckle simplify handling

 Size: S/M/L, XL/XXL, XXXL
 Weight: 1185 g • 41.8 oz (size S/M/L)
 € 1019 • EN 361

BODY II ENERGY SPEED

W0093SY

NEW

Fully adjustable fall-arrest harness with various attachment points, speed buckles and comfortable padding.

- suitable for working situations with maximum freedom of movement during work positioning
- stitched waist belt padding allows horizontal or vertical movement of the padding thus providing maximum comfort during a work.
- side attachment points for work positioning according to EN 358
- front and rear attachment points according to EN 361 marked with „A“ label
- removable and washable shoulder and leg loops padding provides great comfort
- shoulder padding with reflective straps and integrated loops for hooks storage
- webbing stitched in the buckles simplify handling
- two gear loops with max. load 5 kg
- 4 additional plastic hooks for light gear attachment
- different colour of rear triangle for each size (S/M/L- grey, XL/XXL- yellow)
- 2 sizes fit whole size range from 150 to 210 cm

Size: S/M/L, XL/XXL, XXXL

Weight: 2250 g • 79.44 oz (size S/M/L)

CE 1019 EN 361 EN 358



Power supply maintenance, Ponikla, Czech republic Photo: Jiří Bošek



BASIC LIGHT 

W0090SY

**Fully adjustable fall-arrest harness with a rear dorsal attachment point.**

- dorsal rear D-ring attachment point according to EN 361
- one gear loop with max load of 5 kg
- easy to adjust thanks to 4 easy-lock buckles, easy to put on and off
- different color of the rear webbing for each size (S/M/L grey, XL/XXL yellow)
- all steel components finished with E-coating for higher corrosion resistance
- 2 sizes fit whole size range from 150 to 210 cm
- suitable for use with a range of accessories like Pole, Harness Padding, Suspension Trauma Safety Strap

Size: S/M/L, XL/XXL
 Weight: 760 g • 26.81 oz / 810 g • 28.5 oz
 CE 1019 • EN 361

BASIC 

W0089SY

**Fully adjustable fall-arrest harness with rear dorsal and front sternum attachment points.**







- dorsal rear D-ring and front textile twin loops attachment points according to EN 361
- one gear loop with max load of 5 kg
- easy to adjust thanks to 4 easy-lock buckles, easy to put on and off
- different color of the rear webbing for each size (S/M/L grey, XL/XXL yellow)
- all steel components finished with E-coating for higher corrosion resistance
- 2 sizes fit whole size range from 150 to 210 cm
- suitable for use with a range of accessories like Pole, Harness Padding, Suspension Trauma Safety Strap

Size: S/M/L, XL/XXL
 Weight: 820 g • 29 oz / 885 g • 31 oz
 CE 1019 • EN 361



FAVORABLE COMBINATIONS

Singing Rock also offers favorable combinations of the fall-arrest harnesses and range of accessories:

Harness / Accessory	 w/ Padding	 w/Pole II	 w/ Padding and Pole II
 Basic Light	M0023DX	M0023PX	M0023XX
 Basic	M0024DX	M0024PX	M0024PX
 Body II standard	M0025DX	M0025PX	M0025XX
 Body II speed	M0026DX	M0026PX	M0026XX

POLE II

W0073



Belt for work positioning and prevention against the falls from a height.

- anatomic padded waist belt ensures minimal bruising and enough comfort in the waist area
- two side "D" ring for work positioning according to EN 358, tested for 15 kN strength
- two braided gear loops with a bearing capacity of 5 kg
- slots designed for a secure hanging of expensive equipment (such as power saw, drilling machine,...) with a capacity of 1 kN
- speed buckles allow easy manipulation when dressing up and undressing

Recommended use:

- for work positioning and prevention of falls from a height
- possible combination with fullbody fall-arrest harness BODY II

Size: S, M/L, XL
 Weight: (M/L) 595 g • 21 oz
 € 1019 • EN 358

HARNESSES PADDING

W0092BB

Removable shoulder and leg padding intended for Body II, Basic and Basic Light harnesses.

- durable and soft material spreads the tension to a bigger surface to increase the conform of wearing the harness
- reduces the effects of suspension trauma after a fall
- integrated loops on shoulder padding for hooks storage
- removable and washable padding

Size: S/M/L, XL/XXL
Weight: 236 g • 8.33 oz (S/M/L)



CONNECTION STRAP

W2020X080

Extremely light and durable sling intended mainly for connection between rear dorsal attachment point and self-retractable lifelines.

- allows an easy self-connection to the rear EN 361 D-ring
- made out of dyneema
- 15 cm and 5 cm long loops are on both ends of a sling
- big loop is overturned to make a Girth Hitch knot over a D ring

Length: 80 cm
Width: 13 mm
Weight: 40 g • 1.41 oz
CE 1019 • EN 354



SUSPENSION TRAUMA SAFETY STRAP

W1029BX00

Auxiliary sling preventing effects of suspension trauma after a fall.

- helps to relieve pressure in the groin area while a worker is awaiting rescue
- easy to attach to a harness using a girth hitch and velcro strap
- plastic cover increases resistance during normal working activities
- patented Rock&Lock buckle ensures easy length adjustment
- colored stepping loop
- suitable for Body II, Basic and Basic Light harnesses

Weight: 63 g • 2.2 oz
Material: polyamide

SIT WORKER 3D / SPEED

W0076DR
black version – W0076DB



Fully adjustable sit harness for work positioning. The new design of this sit harness is characterized by perfect functionality, great comfort and lightness. Intended for all vertical activities without any risk of the fall.

- super comfortable wide waist belt padding provides maximum comfort when working at height
- strength webbing on the waist belt is stitched in the way that at normal working situation the body weight is absorbed by the padding only
- anatomic leg loops and waist belt are covered with strong PES fabric providing high abrasion resistance
- SPEED buckles enable fluent and fast adjustment to fit a user's body
- side attachment points for work positioning according to EN 358
- front attachment point for descender placement or work positioning according to EN 813, EN 358

- reflective strap and printing on the waist belt increase the visibility in dark working conditions
- 4 ergonomic braided gear loops with a bearing capacity 15 kg
- additional loops on the waist belt and leg loops with a bearing capacity of 5 kg offer additional space for the gear and better gear orientation
- slots on the waist belt for PORTER tool holder to carry your industrial tools

Size: S, M/L, XL

Weight: (M/L) 1515 g • 53.44 oz
€ 1019 • EN 358 • EN 813



SIT WORKER 3D / STANDARD

W0075DR
black version – W0075DB



Fully adjustable sit harness with easy-lock buckles for work positioning.

- thermo finished webbing in a waist belt for easy handling and higher durability
- all steel components finished with E coating for higher corrosion resistance
- super comfortable wide waist belt padding provides maximum comfort when working at height
- side attachment points for work positioning according to EN 358

Size: S, M/L, XL

Weight: (M/L) 1195 g • 42.15 oz
€ 1019 • EN 358 • EN 813



SIT WORKER 3D / SPEED STEEL 

W0077DR

Fully adjustable sit harness for work positioning with the stainless steel components and SPEED buckles.

- SPEED buckles enable fluent and fast adjustment to fit a user's body
- the harness is made in accordance with a strict American standard (NFPA)
- 4 ergonomic braided gear loops with a bearing capacity 15 kg
- super comfortable wide waist belt padding provides maximum comfort when working at height
- side attachment points for work positioning according to EN 358



Size: S, M/L, XL
 Weight: (M/L) 1650 g • 58.2 oz
 CE 1019 • EN 358 • EN 813
 NFPA Class II

URBAN II 

W0022BB

Sit harness for work positioning

- anatomic waist belt and leg loops padding perfectly fits to man anatomy
- textile attachment point for work in hanging position, rappelling according to EN 813.
- textile positioning points according to EN 358 are placed symmetrically, tested for 15 kN strength.
- 2 braided gear loops with a bearing capacity of 10 kg provide enough space for 10 pieces of HMS carabiners
- additional loops with a bearing capacity of 5 kg offer additional space for the gear and better gear orientation
- slots designed for a secure hanging of expensive equipment (such as power saw, drilling machine,..)
- identification and methodical label. To prolong its lifetime is advised to hide this label under the webbing.



Size: S, M/L, XL
 Weight: M/L 850 g (±15g) • 30 oz
 CE 1019 • EN 358 • EN 813





FRANKLIN

W0010YB
black version – W0010BB**Work positioning seat provides more comfort when hanging in the harness.**

- intended for use with our fall arrest or work positioning harnesses
- easy to adjust with Rock&lock buckles. Attachment straps are shorter to fit better to thinner users
- inside padding is made of aluminium which allows long term use without any deformation
- wider sitting area ensures good stability and allows comfortable suspension as well as standing at work positioning
- suspension straps do not press on your thighs

- three D-rings (bearing capacity 50 kg) for bucket or other gear suspension

Max. load of seat: 150 kg

Weight: 1615 g • 57 oz

ALADIN 

C5056

**Chest harness**

- designed to be used together with a sit harness
- optimising body position while hanging or falling
- made from lightweight wide nylon webbing
- very durable and affordable to all climbers

Must be worn with sit harness.
Do not use chest harness alone!

Size: UNI

Weight: 240 g • 8,5 oz

CE 1019 • EN 12277 • RL CHEST 

black version – W0200BB

**Fully adjustable chest harness**

Use only in combination with a sit harness!

Size: UNI

Weight: 600 g • 21.2 oz

CE 1019

TIMBER 3D

Timber 3D – W006IDR



Work positioning harness presenting a perfect choice for the arborists. Ideal solution for those who spend all day in the tree top.

- super comfortable wide waist belt and leg loops padding provides maximum comfort when hanging in the harness
- strength webbing on the waist belt is stitched in the way that at normal working situation the body weight is absorbed by the padding only
- removable and exchangeable bridge connecting the leg loops
- adjustable sliding O-ring enables you to take safe, comfortable and effective work position
- side D-rings for work positioning EN 358 or gear attachment
- anatomic leg loops and waist belt are covered with strong PES fabric providing high abrasion resistance
- 4 gear loops with a bearing capacity of 5 kg provide enough space for your gear.

- rear haul loop with a bearing capacity of 10 kg for the chain saw or other heavy gear
- additional loops at the waist belt and leg loops with a bearing capacity of 5 kg offer additional space for the gear and better gear orientation
- heavier items up to 35 kg can be attached to the webbing on the waist belt
- SPEED buckles enable fluent and fast adjustment to fit a user's body
- rear upper loop for the shoulder straps connection (PULLER)
- rear adjustable loop at the waist belt allows to attach First Aid Kit
- slots at the waist belt for PORTER tool holder to carry your industrial tools

Size: S, M/L, XL

Weight: 1860 g / 1940 g • 65.61 oz / 68.43 oz

CE 1019 • EN 358 • EN 813



Tree care, Brno, Czech republic Photo: Pavel Nesvadba

TREEMOUSE

W9500Y



Arboristic throwing bag for tree climbing

- suitable for installation of the anchor point in a treetop using cambium saver (JINGLE)
- used for dropping small branches down from the tree top
- suitable for installation of the working rope to the places with complicated access

material: high endurance
synthetic fabric PES
steel welded ring of 3 cm in diameter
polyamid webbing
colour: yellow, blue/yellow, blue

TREEMOUSE 300

300 g/yellow/code: W9500Y300

TREEMOUSE 350

350 g/blue/yellow/code: W9500Y350

TREEMOUSE 400

400 g/blue/code: W9500Y400



steel ring – W1040R
ALU ring – W1041R
without ring – W1042R

JINGLE II



Cambium saver intended for use in tree climbing as anchor device and belay anchor. The different size of the rings enables easy and quick installing and removing of the sling from the ground. As well suitable in industry as an anchor device.

- length of the slings with "O" ring – 100, 120, 150 cm
- strength 25 kN
- inside and outside diameter of "O" rings:
ALU: big 46/70 mm, small 28/52 mm
steel: big 58/78, small 38/57

- 3 layers of webbing sewn together
- red colour of webbing for better visibility
- available with aluminium "O" rings or without "O" rings.

CE 1019 • EN 795B



TIMBER BRIDGE

W0070RR00



Replacement connecting loop

Material: polyamide
Width: 20 mm
Length: 32.5 cm
Weight: 37 g

TIMBER ACCESSORY CORD

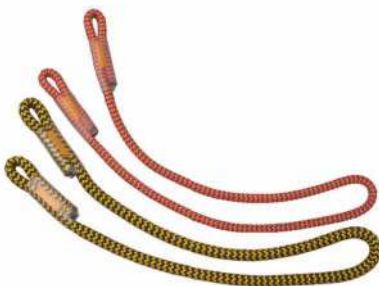
8 mm – W2608
10 mm – W2610

With sewn eyes.

- rope diameter 8 and 10 mm
 - the use of the PES/TECHNORA material combination results in a better thermal and mechanical resistance of the sheath
- Length:
diameter 8 mm – 75, 80, 85, 100 cm
diameter 10 mm – 80, 85, 90, 100 cm

Strength:
18 kN (8 mm)
20 kN (10 mm)

CE 1019 • EN 795B

EVACUATION TRIANGLE SIT II

W8201BY00



Evacuation triangle for a person to rescue from a chair lift or a cable car.

- chest plastic buckle for easy putting on the triangle
- durable steel attachment points
- easy to put on and take off
- adjustable crotch webbing
- made from durable ripstop material

Only for rescue purposes.
Size: UNI • Weight: 800 g • 1.8 lb
EN 1498



EVACUATION TRIANGLE COMBI II

W8211BY00



Evacuation triangle with shoulder straps for a person to rescue from a chair lift or a cable car.

- special shoulder straps for better fixing a person in evacuation triangle
- straps are made from different color for better attachment management
- durable steel attachment points
- easy to put on and take off
- adjustable crotch webbing
- made from durable ripstop material

Only for rescue purposes.
Size: UNI • Weight: 880 g • 1.9 lb
CE 1019 • EN 1497 • EN 1498



LAIKA

W0005YBO9
black version – W0005BB09



Dog harness intended for transport of the dog from a helicopter.

- side light-alloy reinforcements
- easy and quick fastening with velcro
- max. load 150 kg

Size: UNI



BABY RESCUE BAG

W8220



Rescue bag for the children evacuation.

- designed for rescue transporting of the children (height 40-110 cm, max. weight 25 kg)
- safety fixation by 3 belts with Velcro and with the safety straps led to cross during the transporting.
- inner padding is very comfortable and fully removable and washable
- top cover with full zipper and ventilation hole
- stabilization strap of the top cover to prevent the camber of the cover to the face of the child during the transport by the helicopter
- colored loops for the carabiner fixation and adjusting the position of the bag
- side ventilation holes covered by PVC net
- durable material with the reflection elements
- hygienic inner textile cover included

Size: 80x45x35 cm

Weight: 3300 g

Material:

PVC, PAD, PES,

PES / cotton







CE • EN 1497











Ski lift rescue, Paseky nad Jizerou, Czech republic Photo: Ondřej Vítko, www.oreexpert.cz

	type of buckles	black version	code	size	weight M/L [g]	waist [cm/in]	leg loops [cm/in]	height [cm]
EXPERT 3D 	standard	yes	W0078DR02	S	2110	65-80 / 25-31	45-60 / 18-24	150-170
		yes	W0078DR03	M/L		75-100 / 29-39	50-75 / 19-29	160-180
		yes	W0078DR05	XL		85-130 / 33-51	50-75 / 19-29	175-205
	speed	yes	W0079DR02	S	2415	65-80 / 25-31	45-60 / 18-24	150-170
		yes	W0079DR03	M/L		75-100 / 29-39	50-75 / 19-29	160-180
		yes	W0079DR05	XL		85-130 / 33-51	50-75 / 19-29	175-205
	speed steel	no	W0080DR02	S	2685	65-80 / 25-31	45-60 / 18-24	150-170
		no	W0080DR03	M/L		75-100 / 29-39	50-75 / 19-29	160-180
		no	W0080DR05	XL		85-130 / 33-51	50-75 / 19-29	175-205
EXPERT III 	standard	yes	W0078BR02	S	2155	60-80 / 23-31	45-60 / 18-24	150-170
		yes	W0078BR03	M/L		75-100 / 29-39	50-75 / 19-29	160-180
		yes	W0078BR05	XL		85-130 / 33-51	50-75 / 19-29	175-205
	speed	yes	W0079BR02	S	2450	60-80 / 23-31	45-60 / 18-24	150-170
		yes	W0079BR03	M/L		75-100 / 29-39	50-75 / 19-29	160-180
		yes	W0079BR05	XL		85-130 / 33-51	50-75 / 19-29	175-205
	speed steel	no	W0080BR02	S	2665	60-80 / 23-31	45-60 / 18-24	150-170
		no	W0080BR03	M/L		75-100 / 29-39	50-75 / 19-29	160-180
		no	W0080BR05	XL		85-130 / 33-51	50-75 / 19-29	175-205
PROFI WORKER 3D 	standard	yes	W0082DR02	S	2075	65-80 / 25-31	45-60 / 18-24	150-170
		yes	W0082DR03	M/L		75-100 / 29-39	50-75 / 19-29	160-180
		yes	W0082DR05	XL		85-130 / 33-51	50-75 / 19-29	175-205
	speed	yes	W0081DR02	S	1777	65-80 / 25-31	45-60 / 18-24	150-170
		yes	W0081DR03	M/L		75-100 / 29-39	50-75 / 19-29	160-180
		yes	W0081DR05	XL		85-130 / 33-51	50-75 / 19-29	175-205
PROFI WORKER III 	standard	yes	W0081BR02	S	1650	60-80 / 23-31	45-60 / 18-24	150-170
		yes	W0081BR03	M/L		75-100 / 29-39	50-75 / 19-29	160-180
		yes	W0081BR05	XL		85-130 / 33-51	50-75 / 19-29	175-205
	speed	yes	W0082BR02	S	1960	60-80 / 23-31	45-60 / 18-24	150-170
		yes	W0082BR03	M/L		75-100 / 29-39	50-75 / 19-29	160-180
		yes	W0082BR05	XL		85-130 / 33-51	50-75 / 19-29	175-205
TECHNIC 	standard	yes	W0063BB02	S	1620	65-80 / 25-31	45-60 / 18-24	150-170
		yes	W0063BB03	M/L		75-100 / 29-39	50-75 / 20-29	160-180
		yes	W0063BB05	XL		85-130 / 33-51	50-75 / 20-29	175-205
	speed steel	yes	W0064BB02	S	2450	65-80 / 25-31	45-60 / 18-24	150-170
			W0064BB03	M/L		75-100 / 29-39	50-75 / 20-29	160-180
			W0064BB05	XL		85-130 / 33-51	50-75 / 20-29	175-205
ROOF MASTER 	mix	no	W0091BY02	S	1570	65-80 / 25-31	45-60 / 18-24	
		no	W0091BY03	M/L		75-100 / 29-39	50-75 / 19-29	160-180
		no	W0091BY03	XL		85-130 / 33-51	50-75 / 19-29	175-205



	type of buckles	black version	code	size	weight M/L [g]	waist [cm/in]	leg loops [cm/in]	height [cm]
SEAMASTER 3D 		no	W0074DR03	S		65-80 / 25-31	45-60 / 18-24	150-170
		no	W0074DR03	M/L	1870	75-100 / 29-39	50-75 / 19-29	160-180
		no	W0074DR05	XL		85-130 / 33-51	50-75 / 19-29	175-205
ANTISHOCK I 	standard	no	W0086B002	S	2100	55-80 / 22-31	45-60 / 18-24	150-170
		no	W0086B003	M/L		75-100 / 29-39	50-75 / 20-29	160-180
		no	W0086B005	XL		85-130 / 33-51	50-75 / 20-29	175-205
TARZAN 	mix	no	W0050BR02	XS-S	1530	50-80 / 20-31	45-60 / 18-24	145-165
		no	W0050BR05	M-XL		70-130 / 27-51	50-75 / 19-29	160-205
TARZAN ECONOMIC 			W0059BR	UNI	1050	UNI	59-78	150-200
				S			43-78	110-150
ROPEDANCER II 	mix	no	W0087BY01	XS	1195	UNI	UNI	125-155
		no	W0087BY03	S/M/L		UNI	UNI	150-185
		no	W0087BY05	XL/XXL		UNI	UNI	180-210
BODY II 	standard	yes	W0068BR03	S/M/L	1025	UNI	45-70 / 18-27	150-185
		yes	W0068BR05	XL/XXL		UNI	45-85 / 18-33	180-210
		yes	W0068BR07	XXXL		UNI	45-95 / 18-39	150-185
	speed	yes	W0071BR03	S/M/L	1185	UNI	45-70 / 18-27	
		yes	W0071BR05	XL/XXL		UNI	45-85 / 18-33	150-185
		yes	W0071R07	XXXL		UNI	45-95 / 18-39	150-185

	type of buckles	black version	code	size	weight M/L [g]	waist [cm/in]	leg loops [cm/in]	height [cm]
BODY II ENERGY SPEED 	speed	no	W0093SY	S/M/L	2250	75-130 / 29-51	55-75 / 22-29	150-185
		no		XL/XXL		85-145 / 33-57	65-90 / 25-35	180-210
				XXXL		85-155 / 33-61	65-105 / 25-41	180-210
BASIC 	mix	no	W0089SY03	S/M/L	820	UNI	45-70 / 18-27	150-185
		no	W0089SY05	XL/XXL		UNI	45-85 / 18-33	180-210
BASIC LIGHT 	mix	no	W0090SY03	S/M/L	760	UNI	45-70/18-27	150-185
		no	W0080SY05	XL/XXL		UNI	45-85/18-33	180-210
POLE II 	RL buckle	yes	W0073BR02	S	450	65-80 / 25-31		
		yes	W0073BR03	M/L		75-100 / 29-39		
		yes	W0073BR05	XL		85-130 / 33-51		
SIT WORKER 3D 	standard	yes	W0075DR02	S	1195	65-80 / 25-31	45-60 / 18-24	
		yes	W0075DR03	M/L		75-100 / 29-39	50-75 / 19-29	
		yes	W0075DR05	XL		85-130 / 33-51	50-75 / 19-29	
	speed	yes	W0076DR02	S	1515	65-80 / 25-31	45-60 / 18-24	
		yes	W0076DR03	M/L		75-100 / 29-39	50-75 / 19-29	
		yes	W0076DR05	XL		85-130 / 33-51	50-75 / 19-29	
	speed steel	no	W0077DR02	S	1650	65-80 / 25-31	45-60 / 18-24	
		no	W0077DR03	M/L		75-100 / 29-39	50-75 / 19-29	
		no	W0077DR05	XL		85-130 / 33-51	50-75 / 19-29	
URBAN II 	standard	yes	W0022BB02	S	850	65-80 / 25-31	45-60 / 18-24	
		yes	W0022BB03	M/L		75-100 / 29-39	50-75 / 19-29	
		yes	W0022BB05	XL		85-130 / 33-51	50-75 / 19-29	

	type of buckles	black version	code	size	weight M/L [g]	waist [cm/in]	leg loops [cm/in]	height [cm]
ALADIN	double buckle	yes	C5056	UNI	240			
								
RL CHEST	RL buckle	yes	W0200BB	UNI			chest max. 125 / 49	
								
	mix	no	W006DR02	S	1860	55-80 / 21-31	45-60 / 18-24	
		no	W006DR03	M/L		70-100 / 28-39	50-65 / 20-25	
		no	W006DR05	XL		85-130 / 33-51	55-75 / 22-29	



Weather and emergency station installation, Norway Photo: Pavel Nesvadba



ROPES

STATIC
DYNAMIC
SPECIAL
SPELEO
CORDS
ACCESSORIES

ROPES



STATIC ROPES

Excellent quality static ropes intended for rope access, rescue or manipulation with objects. Static ropes meet the highest requirements for workers at height, firemen, rescuers and other professionals.

- Pack 30, 40, 50, 60, 70, 80, 100 m coil, 100, 200 m spool or the length on customer's request

ULTRASONIC

ULTRASONIC ending is an excellent way of rope ending.

All SINGING ROCK ropes are ended by a unique technology ULTRASONIC.

The load-bearing core and the protective sheath are joined into a compact unit in the last 15 mm of the rope which eliminates the sheath slippage.

STITCHED EYE



All SINGING ROCK ropes which are marked with Stitched eye icon are possible to be produced with one or two stitched eyes at the end of the rope.

STATIC R44 10.5



L0430WR	white
L0430RR	red
L0430BB	black
L0430KK	khaki

CE 1019 • EN 1891
 • NFPA



STATIC R44 11.0

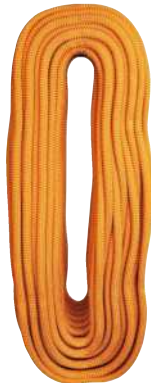

L0450WG	white
L0450RR	red
L0450BB	black
L0450OO	orange

CE 1019 • EN 1891
 • NFPA

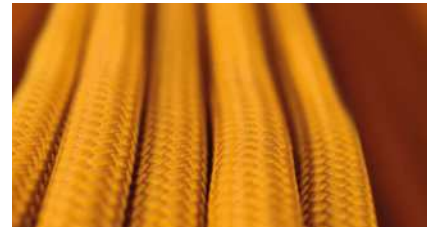

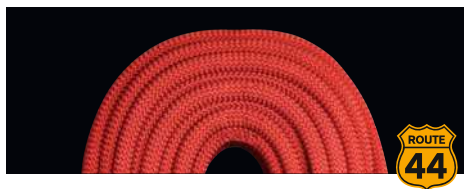

ROUTE 44

experience the touch of the future

Route 44 is unique technology invented and patented by Singing Rock. Route 44 technology allows blending of properties that were considered impossible before. Rope braided by using Route 44 technology is more compact, softer and above all it is more durable than conventional rope. All that is achieved by making no compromises in using correct sheath thickness, which is round-braided by 44 carriers. These features combine to give you better rope.



TEFLON® DUPONT®

Selected SINGING ROPES are produced with a DuPont™ TEFLON® fabric protector license.

Ropes protected by a TEFLON® layer have extraordinary water and abrasion resistance. The TEFLON® layer also effectively prevents the intrusion of dust particles into the rope structure and thus increases its lifespan.



STITCHED EYE

Selected SINGING ROCK static ropes which are marked with Stitched eye icon are possible to produce with one or two stitched eyes at the end of the rope.

STATIC 10.5



- L0230WR white
- L0230RR red
- L0230BB black
- L0230KK khaki

CE 1019 • EN 1891 • UAA



STATIC 11.0



- L0250WR white
- L0250RR red
- L0250BB black

CE 1019 • EN 1891 • UAA • NFPA



STATIC R44 10.5

MILITARY: This collection of static ropes has been specially prepared for the use of police and army forces and other special units. If you require the best quality and a special design, MILITARY ropes are the best choice.



L0430BB black
L0430KK khaki

CE 1019 • EN 1891 • NFPA • UAA

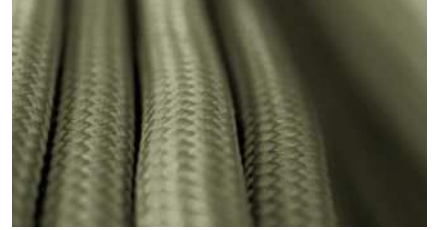

STATIC R44 11.0



L0450BB black

CE 1019 • EN 1891 • NFPA • UAA



STATIC 11.0 / STATIC 10.5



Static 11.0
L0250BB black
CE 1019 • EN 1891 • NFPA • UAA

Static 10.5
L0230BB black
L0230KK khaki
CE 1019 • EN 1891 • UAA



STATIC 9.0



L0220WR white
L0220BB black

CE 1019 • EN 1891 • 



CONTRA 10.5

L026

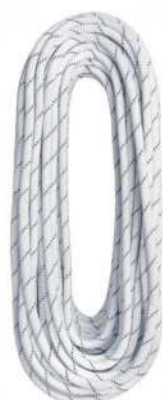

Static rope for various purposes.

CE 1019 • EN 1891 • 



SPELEO



L0440WR
SPELEO R44 10.5

L0240WR
SPELEO 10.5
CE 1019 • EN 1891 • 



ICON DRY 9.3

L0384RX

Excellent single rope for high-level climbers or glacier/mountain usage thanks to its lightness and water resistance.

- extremely lightweight and robust; it is ideal for hard routes on sight, flash or redpointing where every gram counts
- produced on 44-carrier machine, Route 44, Singing Rock's patented technology
- with our special Teflon® treatment Icon 9.3 Dry is ideal for rock climbing, pump routes or extreme ascents in the mountains
- TEFLON® is applied on the ropes by revolutionary nanotechnology

- the sheath is more resistant against breakage, but on the other hand it is smoother
- Teflon® Treatment
- Thermotransfer end marking
- Middle marking
- Ultrasonic ending

CE 1019 • EN 892 • UAA • ①

ICON 9.3

L0380YX

Excellent single rope for high-level climbers.

- extremely lightweight and robust; it is ideal for hard routes on sight, flash or redpointing where every gram counts
- produced on 44-carrier machine, Route 44, Singing Rock's patented technology
- this unique technology gives to the rope great handling, low-weight and high durability
- the sheath is more resistant against breakage, but on the other hand it is smoother

- Thermotransfer end marking
- Middle marking
- Ultrasonic ending

CE 1019 • EN 892 • UAA • ①

HERO DRY 9.6

L0524GW

A top-class single rope with low weight and great handling qualities for high-level climbers.

- Single Tech construction provides increased resistance to abrasion and great handling qualities
- rope is soft and easy to manipulate in the belay devices
- although having a small diameter, this rope provides long lifespan
- special Teflon® treatment provides longer lifetime during the usage

- TEFLON® is applied on the ropes by revolutionary nanotechnology
- ideal for sport climbing and single pitch ice climbing
- Teflon® Treatment
- Thermotransfer end marking
- Middle marking
- Ultrasonic ending

CE 1019 • EN 892 • UAA • ①

HERO 9.6

L0520GW

Excellent single rope for sport climbers.

- Single Tech construction provides increased resistance to abrasion, low weight and great handling qualities
- rope is soft and easy to manipulate in the belay devices
- even with a small diameter, this rope provides long lifespan
- Thermotransfer end marking
- Middle marking
- Ultrasonic ending

CE 1019 • EN 892 • UAA • ①

KATA DRY 9.7

L0580AA



High-end climbing single rope with high safety factors and extremely high durability. Suitable for both experienced climbers and beginners.

- the unique patented InterCore technology provides maximum safety even in case of a damaged sheath
- narrow diameter and great handling provide easy manipulation in all belay devices
- thanks to the sandwich-type construction of braided layers and the use of specially

developed staple fibres the rope has super high resistance to abrasion.

- special Teflon treatment provides longer lifetime during the usage. Teflon treatment is applied on the core and sheath by revolutionary nanotechnology.
- Thermotransfer end marking
- Middle marking
- Ultrasonic ending
- Teflon® Treatment

CE1019 • EN 892 • UAA • ①

KATA 9.7

L057AA



High-end climbing single rope with high safety factors and extremely high durability. Suitable for both experienced climbers and beginners.

- narrow diameter and great handling provide easy manipulation in all belay devices
- the unique patented InterCore technology provides maximum safety even in case of a damaged sheath
- thanks to the sandwich-type construction of braided layers and the use of specially

developed staple fibres the rope has super high resistance to abrasion.

- Thermotransfer end marking
- Middle marking
- Ultrasonic ending

CE1019 • EN 892 • UAA • ①

STORM DRY 9.8

L3044AG00

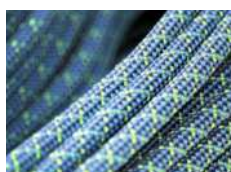

Single rope with great balance in weight, durability and use. Perfect choice for all-round climbing.

- this rope provides great handling, low-weight and high durability
- special Teflon® Eco treatment provides longer lifetime during the usage
- TEFLON® is applied on the ropes by revolutionary nanotechnology which makes the top of the line impregnated ropes
- narrow diameter and higher UIAA fall rating (UIAA falls 9) help you to improve your climbing achievements

- ideal for all-round climbing, training hard routes and RP ascents.
- Teflon® Treatment
- Thermotransfer end marking
- Middle marking
- Ultrasonic ending

CE 1019 • EN 892 • UAA • ①

STORM 9.8

L3040GA00



Single rope with great balance in weight, durability and use. Perfect choice for all-round climbing.

- narrow diameter and higher UIAA fall rating (UIAA falls 9) help you to improve your climbing achievements
- this rope provides great handling, low-weight and high durability
- the rope is very compact, durable and pleasant to use
- ideal for all-round climbing, training hard routes and RP ascents.

- Thermotransfer end marking
- Middle marking
- Ultrasonic ending

CE 1019 • EN 892 • UAA • ①

MYSTIC DRY 10.1

L0534AG

Great single rope with an unusual design.

- Single Tech construction provides high resistance to abrasion, great handling qualities and low weight
- runs smoothly in all devices on the market
- special TEFLON® treatment provides longer lifetime during the usage
- TEFLON® is applied on the ropes by revolutionary nanotechnology
- perfect choice for all-round climbers
- TEFLON® Treatment
- Thermo-transfer end marking

- Middle marking
- Ultrasonic ending

CE 1019 • EN 892 • UAA • ①

MYSTIC 10.1

L0530RA

Great single rope with an unusual design.

- Single Tech construction provides low weight, high resistance to abrasion and great handling qualities
- extraordinary durability and excellent technical performance
- perfect choice for all-round climbers
- Thermo-transfer end marking
- Middle marking
- Ultrasonic ending

CE 1019 • EN 892 • UAA • ①

GYM 10.1

L3050RY00

Single rope specially invented for the climbing gyms, adventure parks or rope courses.

- this rope is designed for heavy usage with high safety factors and extremely high durability
- special technology of braided core gives the rope great resistance parameters
- braided core and compact sheath minimize the inter-fiber friction which give the result of the increased resistance to abrasion mainly when top-ropeing

- narrow diameter and great handling provide easy manipulation in all belay devices
- ideal for climbing schools, gyms, adventure parks and rope courses.
- thermo-transfer end marking
- ultrasonic ending

CE 1019 • EN 892 • UAA • ①

SCORE 10.1

L0360GG

Great rope for sport climbing with excellent visibility.

- made by Singing Rock patented technology R44, which gives to the rope well-balanced rate of weight and diameter
- this unique technology gives to the rope great handling, low-weight and high durability
- rope is very compact, durable and pleasant to use
- suitable for all belay devices on the market
- Thermo-transfer end marking

- Middle marking
- Ultrasonic ending

CE 1019 • EN 892 • UAA • ①

DURAN 10.4

L0340AX

**Ideal rope for indoor climbing and crags with rough rocks.**

- made by Singing Rock patented technology R44, which gives to the rope well – balanced rate of weight and diameter
- rope is very compact, durable and pleasant to use
- rope has thicker sheath with perfect abrasion resistance still keeping good handling characteristics
- suitable for the most types of belay devices on the market

- Thermotransfer end marking
- Middle marking
- Ultrasonic ending

CE 1019 • EN 892 •  • ①

PATRON 11.0

L0540YX

**Dynamic single rope with high safety factor and great durability.**

- designed for heavy usage in rope training centres, climbing schools and rescue situations
- rope has thicker sheath with perfect abrasion resistance
- suitable for the most types of the belay devices on the market
- Thermotransfer end marking
- Middle marking

- Ultrasonic ending
- suitable for IRATA cow's tails

CE 1019 • EN 892 •  • ①



ACCORD DRY 8.3

L0514

**Half and twin rope with excellent durability and special Teflon® treatment.**

- tested and certified according to the EN 892 standard requirements for half ropes and twin ropes.
- with our special Teflon® treatment is ideal for ice climbing or wet conditions in the mountains
- Teflon® is applied on ropes by revolutionary nanotechnology.
- weight, diameter and number of falls are balanced in such a way that can be used as a half and twin rope.

- used in pairs, the climber can choose between the twin rope technique or half rope technique. Whatever technique is required at the time.
- Thermotransfer end marking
- Ultrasonic ending

CE 1019 • EN 892 •  • 1/2 • 



ACCORD 8.3

L0510

**Half and twin rope with excellent durability and lightness.**

- compact rope which has minimal interfiber friction, thereby increasing durability.
- tested and certified according to the EN 892 standard requirements for half ropes and twin ropes
- weight, diameter and number of falls are balanced in such a way that can be used as a half and twin rope
- used in pairs, the climber can choose between the twin rope technique or half

- rope technique. Whatever technique is required at the time.
- Thermotransfer end marking
- Ultrasonic ending

CE 1019 • EN 892 •  • 1/2 • 

GEMINI 7.9

L3020



Half and twin rope for those who count every gram.

- lightweight rope with top parameters allows wide use: ice climbing, mix routes, glacier tours or mountaineering
- tested and certified according to EN 892 standard requirements as half rope and twin rope
- with our special TEFLON® treatment Gemini 7.9 is ideal for ice climbing or extreme ascents in the mountains
- TEFLON® is applied on ropes by revolutionary nanotechnology

- used in pairs, the climber can choose between the twin rope technique or half rope technique. Whatever technique is required at the time
- TEFLON® Treatment
- Thermotransfer end marking
- Ultrasonic ending

CE 1019 • EN 892 • UAA • 12

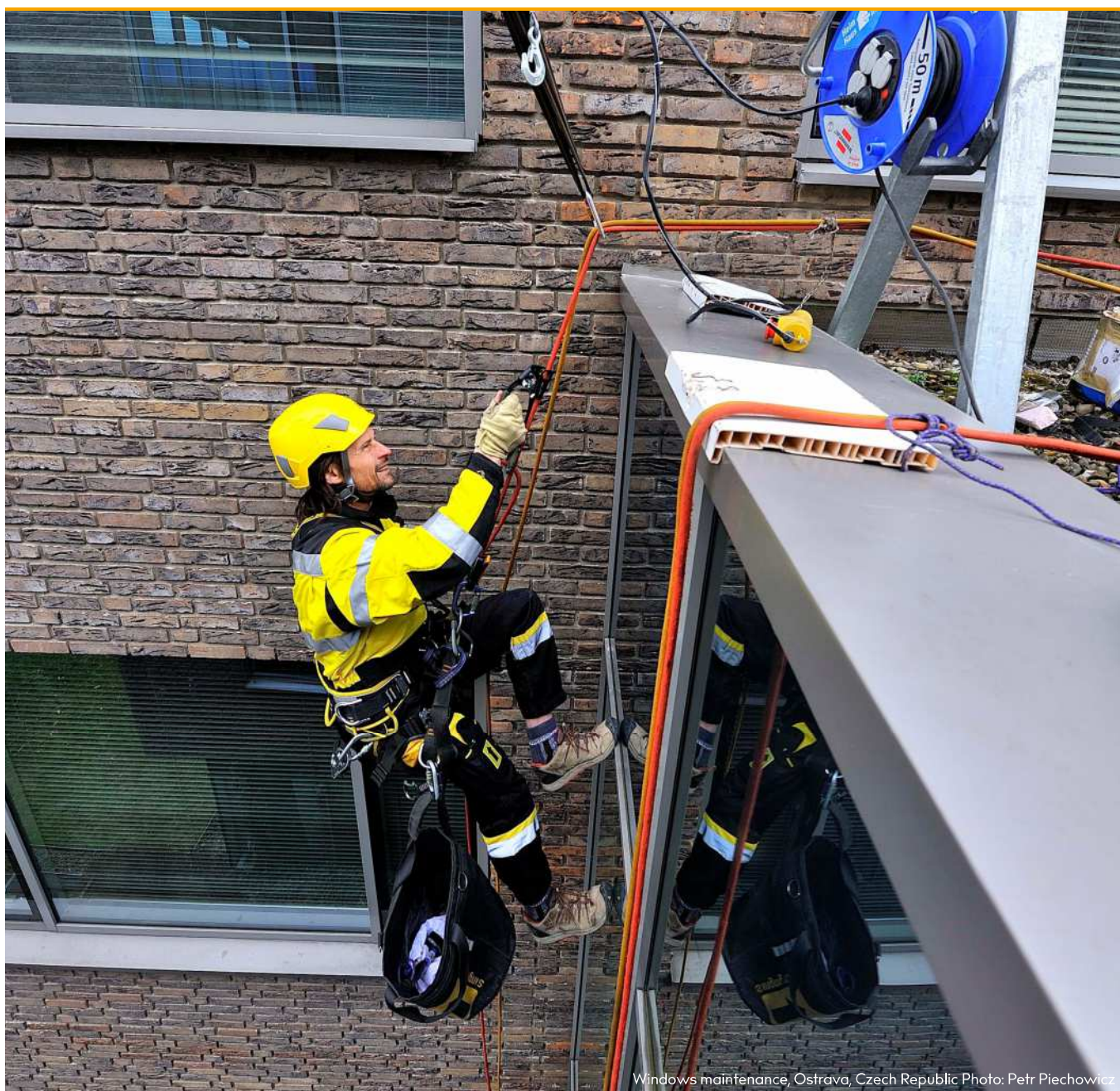

Windows maintenance, Ostrava, Czech Republic Photo: Petr Piechowicz

THERMOCUTTER

X0004GB



The ideal machine for cutting the ropes and accessory cords. Compact hand-held.

The blade heats quickly. For save and fast cutting the ropes.

ROPEMARKER

E0015XX



When you need to mark your rope, use SINGING ROCK Rope Marker

- with dark ink and easy-to-use design, you'll never be left wondering in those unsure situations
- when the middle marking fades you can mark it again with this specially formulated rope marker
- you can mark the center of ropes or any other part of the harness or sling

For use with: PA, PP, PES, PE.

COW'S TAIL

L0540C450



4,5 m long piece of 11mm dynamic rope to create lanyards using figure eight knots according to IRATA recommendations.

Length: 4.5m
Rope diameter: 11mm
CE 1019 • EN 892 • 



HAMMER CORD

2 mm – L0002
3 mm – L0003



Durable, strong, easy to tie, for example for securing climbing equipment, backpack, tools or laces. Suitable for climbing purposes, guiding or work at height.

Strength: 1.2 kN / 1.9 kN

ACCESSORY CORD

L0041 – L0081



Suitable for a multitude of uses, SINGING ROCK accessory cords are strong and supple.

- easy handling
 - strong
 - multitude of uses
- Diameters: 4, 5, 6, 7 and 8 mm

CE 1019 • EN 564 • 

THROW LINE

L9031YX10



Perfect throwline providing high levels of efficiency to tree climbers.

- excellent sheath-core bond maintains a round cross-section, ensuring good rope glide through the tree
- high visible yellow color for better orientation in the treetop

Diameter: 3mm
Weight: 2,5 g/m
Strength: 0,8 kN
Material: PE (Polyethylen)

ATIKA ROPE PROTECTOR

RK900PP00

NEW



Very stable rope protector.

- made of stainless steel
- rubber layer on the lower side eliminates unwanted movement
- ensures safe work at height and load lifting over sharp edges

Weight: 1450 g / 51 oz
Material: stainless steel + rubber



ROPE PROTECTOR

W8100B



Protects rope sheath against abrasion on rough surfaces.

50/70/100/120 cm • 20/28/40/48 in
Material: PVC
Colour: mix colours

DEFENDER

W1027B



Protects rope sheath against abrasion on rough surfaces.

Allows to put 2 ropes in.

80/120 cm • 32/48 in
Material: Cortex

EDGE ROLLER

set – K0050OS03



Compact light edge roller for rope protection made from aluminium alloy.

- suitable for working on the sharp edges
- protects a moving rope against the abrasion.
- fully adjustable to any work situation
- intended for safe work at height or heavy weights hauling
- parts are connected by maillons. Number of parts can be added as needed
- modular perfectly copy the terrain

- anodized side plates
- set includes 3 parts of edge roller and 4 maillons

Weight: 777g • 27.41 oz

EDGE ROLLER – PART

K0050OS01



- it is possible to extend the size of Edge Roller set by adding the separate moduls

Weight: 232g • 8.18 oz

DYNAMIC ROPES

		code	colour	length* [m]	diameter [mm]	weight [g/m]	static elong. [%]	dynamic elong. [%]	falls	impact force [kN]	type
	ICON DRY	L0384RX	red	30 – 80. 100. 200	9.3	57	9.0	33.9	5	8.4	single
	ICON	L0380YX	yellow	30 – 80. 100. 200	9.3	57	9.0	33.9	5	8.4	single
	HERO DRY	L0524GW	blue	30 – 80. 100. 200	9.6	60	6.3	36.5	8	7	single
	HERO	L0520GW	white	30 – 80. 100. 200	9.6	60	6.3	36.5	8	7	single
	KATA DRY	L0580AA	azul	30-200	9.7	61	9.0	30	5	7.7	simples
	KATA	L057AA	azul	30-200	9.7	61	9.0	30	5	7.7	simples
	STORM DRY	L3044AG	blue	30 – 80. 100. 200	9.8	65	6.3	35	9	9.1	single
	STORM	L3040GA	green	30 – 80. 100. 200	9.8	65	6.3	35	9	9.1	single
	GYM	L3050RY	red	30 – 80. 100. 200	10.1	68	7.4	37	6	7.9	single
	MYSTIC DRY	L0534AG	rainbow	30 – 80. 100. 200	10.1	68	5.7	32	9	7.9	single
	MYSTIC	L0530RA	rainbow	30 – 80. 100. 200	10.1	68	5.7	32	9	7.9	single
	SCORE	L0360GG	green	30 – 60. 80. 100. 200	10.1	66	7	31.9	8	9.1	single
	DURAN	L0340AX	blue	30 – 60. 80. 100. 200	10.4	70	6	31.3	10	8.7	single
	PATRON	L0540YX	yellow	30 – 80. 100. 200	11.0	78	6	33.8	16	8.2	single
	ACCORD DRY	L0514OG	orange	30 – 70. 100. 200	8.3	43	9 / 6.4	32 / 34	5 / 15	5.9 / 9.7	half / twin
		L0514GO	green	30 – 70. 100. 200	8.3	43	9 / 6.4	32 / 34	5 / 15	5.9 / 9.7	half / twin
	ACCORD	L0510AG	blue	30 – 70. 100. 200	8.3	43	9 / 6.4	32 / 34	5 / 15	5.9 / 9.7	half / twin
		L0510GA	green	30 – 70. 100. 200	8.3	43	9 / 6.4	32 / 34	5 / 15	5.9 / 9.7	half / twin
	GEMINI	L3020	red	30 – 70. 100. 200	7.9	39	8 / 7.3	33 / 29	5 / 16	5.7 / 8.3	half / twin
		L3020	yellow	30 – 70. 100. 200	7.9	39	8 / 7.3	33 / 29	5 / 16	5.7 / 8.3	half / twin

CE • EN 892 • • packaging dynamic ropes: pack – 30. 40. 50. 60. 70. 80. 100 m • coil – 200 m

STATIC ROPES

		code	strength [kN]	knot breaking force [kN]	stitched eye strength [kN]	static elongation [%]	number of falls	weight [g/m]	type
	STATIC R44 10.5	L0430	31.5	19.8	27.7	3.4	>15	72	A
	STATIC R44 11	L0450	34.9	22.3	28.5	3.2	>20	77	A
	STATIC 9	L0220	25.5	14.5	–	3.5	>8	52.9	B
	STATIC 10.5	L0230	30.4	18.6	24.3	3.3	>10	69	A
	STATIC 11	L0250	34.5	22.0	28.1	3.3	>20	80	A
	CONTRA 10.5	L026	30.4	18.6	24.3	3.3	>10	69	A

CE • EN 1891 • • packaging static ropes: pack – 30. 40. 50. 60. 70. 80. 100 m • coil – 100. 200 m

Static rope characteristic

Type A rope – low stretch kernmantel rope designed for general use by persons in rope access including all kinds of work positioning and restraint; in rescue and in caving Type B rope – low stretch kernmantel rope of a lower performance than type A ropes, requiring greater care in use (standard does not content other specification).

Static strength defined in the standard

22 kN for the ropes of type A

18 kN for the ropes of type B

Another standard requirement says, the material used for rope produ-

ction shall have the melting point higher than 195 °C, so polyethylene or polypropylene are not suitable for the production of the ropes.

Rope elongation

The rope elongation shall not be higher than 5%, tested by loading the rope for 3 min with 150kg load (pretension 50 kg)

Dynamic performance









Fall test with two meters long rope terminated with figure-eight knots; fall factor 1. The testing mass 100 kg for type A ropes, 80 kg for type B ropes.

SPELEO ROPES

	strength [kN]	knot breaking force [kN]	static elongation [%]	number of falls	weight [g/m]
 SPELEO R44 10.5	35.6	22.1	3.4	>15	72
SPELEO 10.5	29.2	18	3.3	>10	69

CE • EN 1891 •  packaging speleo ropes: pack – 30, 40, 50, 60, 70, 80, 100 m • coil – 100, 200 m

ACCESSORY CORDS

coil	diameter [mm]	weight [g/m]	strength [kN]	length [m]	ft
 L0021	2	2.8	1.2	100	328
 L0031	3	6.5	1.9	100	328
 L0041	4	12.6	3.2	100	328
 L0051	5	18.7	5	100	328
 L0051BB	5	18.7	5	100	328
 L0061	6	23.2	9	100	328
 L0061BB	6	23.2	9	100	328
 L0071	7	35.1	11.5	100	328
 L0081	8	39.8	16	100	328

CE 1019 • EN 564 •  note: Hammer Cords L0002, L0003 do not fulfill EN standards and CE

ROPE TERMINOLOGY:

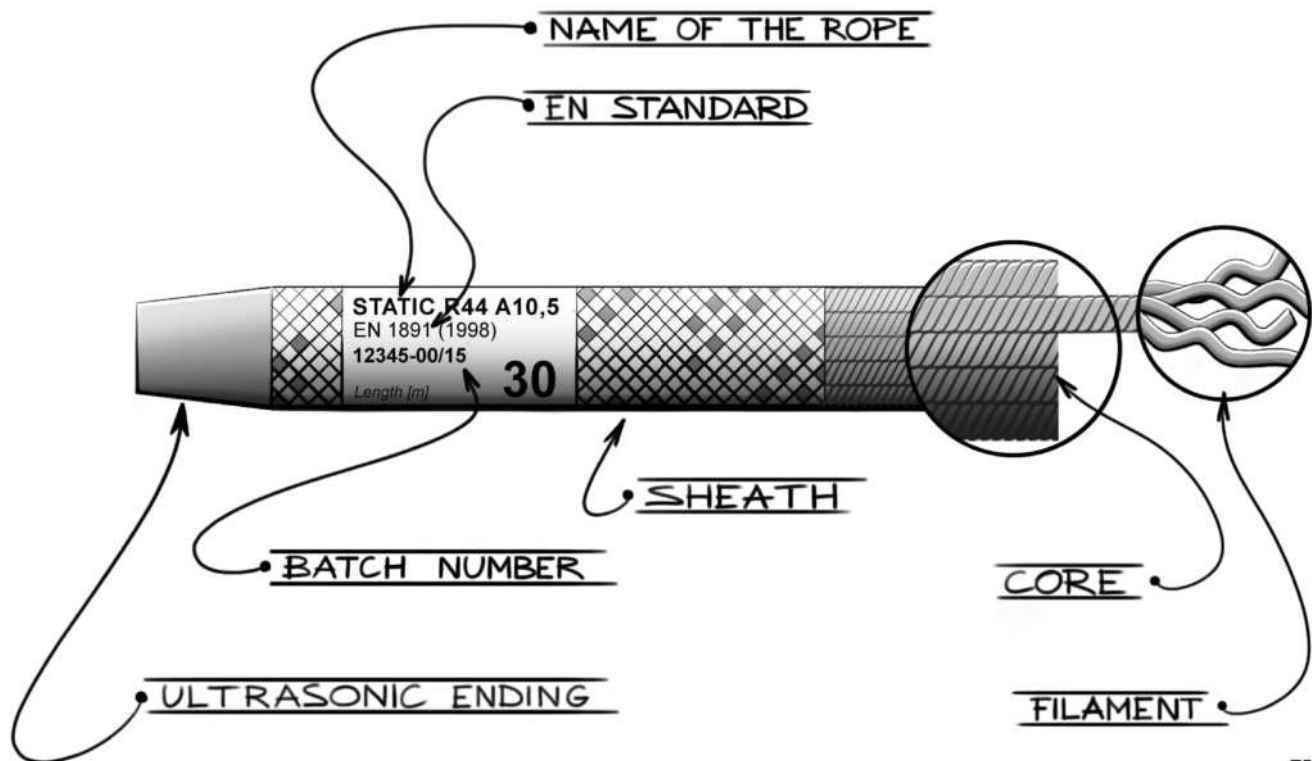

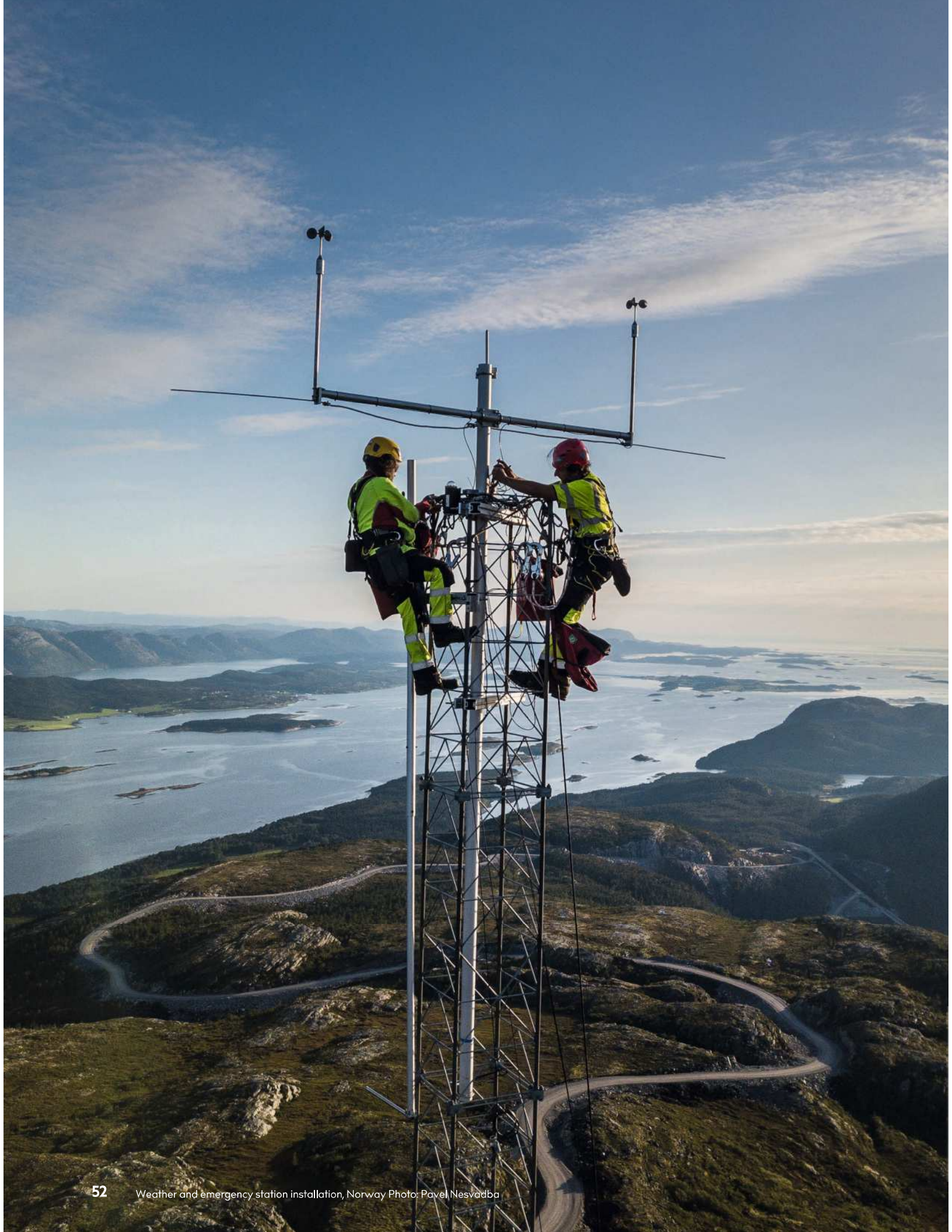

CONNECTORS

STEEL
LIGHT ALLOY
ACCESSORY CARABINERS



HECTOR / SCREW HECTOR / TRIPLE LOCK

screw – K0114EE00
screw black – K0114BB00
triple lock – K0121EE00
triple lock black – K0121BB00



Large versatile pear-shaped HMS carabiner with screw/triple lock gate designed for multiple uses mainly for belaying or anchoring when working at height. Due to high strength and large gate opening it is mainly used as a central carabiner when anchoring.

- pear-shaped basket facilitates belaying with the Mütner hitch or other belay devices
- angled snag free Keylock nose for smooth clipping and unclipping maneuvers
- rough notches on the screw /triple locking sleeve for easy manipulation even with gloves
- each carabiner is individually tested for a strength of 10 kN
- large rope bearing area for better rope glide and reduced wear on the carabiner
- gate opening and basket area are large enough to easily accommodate a big anchor point or more slings
- hot-forged I-beam construction makes the carabiner extremely strong, stiff and light

- excellent ergonomic provides perfect handling with the carabiner
- anodized finishing increases corrosion resistance

Strength: \leftrightarrow 30 \diamond 9 \subset 8 kN
Gate opening (d): 26 mm
Weight: screw – 83 g / 2.9 oz
triple – 89 g / 3.1 oz

CE 1019 • EN 12275 • EN 362

HECTOR BC / SCREW HECTOR BC / TRIPLE LOCK

screw BC – K0114EC00
screw BC black – K0114BC00
triple BC – K0121EC00
triple BC black – K0121BC00



Large versatile pear-shaped HMS carabiner with screw/triple lock gate and removable captive bar designed especially as a fixed connector in anchor systems or lanyards.

- captive bar keeps the carabiner in its proper orientation
- bar is easily removable with an Allen key no. 3
- this carabiner keeps your gear well-arranged and minimizes the chance of cross loading

Strength: \leftrightarrow 30 \diamond 9 \subset 8 kN
Gate opening (d): 26 mm
Weight: screw – 85 g / 3 oz
Triple – 91g / 3.2 oz

CE 1019 • EN 12275 • EN 362

BORA / SCREW, BORA / TWL
BORA / TRIPLE LOCK

screw – K0107EE00
screw black – K0107BB00
TWL – K0108EE00

TWL black – K0108BB00
triple lock – K0119EE00
triple lock black – K0119BB00



BORA screw

Versatile pear-shaped HMS locking biner designed for belaying, rappelling and anchor building.

- hot-forged I-beam construction makes the carabiner extremely strong, stiff and light
- large rope bearing area for better rope glide and reduced wear on the carabiner
- pear-shaped basket facilitates belaying with the MÜNTER hitch or other belay devices
- angled snag free Keylock nose for smooth clipping and unclipping maneuvers
- opening and basket area are large enough to easily accommodate the clove hitch
- available with screw, twist and triple lock gate, all of them easy to handle
- for better gear management the screw gates are in different colors
- each carabiner is individually tested for the strength 10 kN
- unique production number for better traceability and inspection

Strength: \blacklozenge 23 \blacklozenge 8 \blacklozenge 8 kN
Gate opening (d): 22 mm
Weight:
Screw 63 g / 2.22 oz
TWL/Triple lock 68 g / 2.4 oz
CE 1019 • EN 12275 • EN 362 • UAA



Bora triple



Bora TWL

BORA GP / SCREW

K0107EP00
black – K0107BP00



HMS carabiner designed specifically to eliminate the dangers of cross loading.

- safety wire gate keeps the carabiner in its proper orientation
- hot-forged I-beam construction offers an improved strength/weight ratio
- large rope bearing area for better rope glide and reduced wear on the carabiner
- screw locking sleeve for great handling and effective locking
- very popular for climbing gyms and ropes centres

- each carabiner is individually tested for the strength 10 kN
- unique production number for better traceability and inspection

Strength: \blacklozenge 23 \blacklozenge 8 \blacklozenge 8 kN
Gate opening (d): 22 mm
Weight: 64 g / 2.26 oz
CE 1019 • EN 12275 • EN 362 • UAA

COLT / SCREW

 K0112EE00
 black – K0112BB00

Our smallest, super light locking carabiner. Ideal for belaying and anchor building on trad and alpine climbs.

- hot-forged I-beam construction makes the biner very light and still extremely strong with 11 kN gate open rating
- angled snag free Keylock nose for smooth clipping and unclipping maneuvers
- ergonomic shape and gate position designed to provide large opening and large basket area
- screw locking sleeve for great handling and effective locking
- for better gear management the screw gates are in different colors
- each carabiner is individually tested for the strength 10 kN
- unique production number for better traceability and inspection

Strength: \blacktriangleleft 26 \blacktriangleright 8 \square 11 kN
 Gate opening (d): 18 mm
 Weight: 48 g / 1.69 oz
 CE 1019 • EN 12275 • EN 362 •

 COLT / STRAIGHT
 COLT / BENT

 straight – K0111EE00
 straight black – K0111BB00
 bent – K0110EE00
 bent black – K0110BB00

Full size size hot forged carabiner with solid gate. This real all-round biner is engineered to be used for accessory cords, gear attachment and other purposes.

- hot-forged I-beam construction makes the biner very light and still extremely strong with 11 kN gate open rating
- the overall shape and gate position designed to provide large opening and large basket area
- angled snag free Keylock nose for smooth clipping
- shaped grooves on the straight gate facilitate clipping and unclipping
- large rope bearing radius reduces the wear of rope
- available with straight and bent gate
- each carabiner is individually tested for the strength 10 kN

Strength: \blacktriangleleft 26 \blacktriangleright 8 \square 11 kN
 Gate opening (d): 21 mm
 Weight: 42 g • 1.48 oz
 CE 1019 • EN 12275 •

OXY / SCREW, OXY / TWL,
OXY / TRIPLE LOCK

Screw – K0122EE05
Screw black – K0122BB05
TWL – K0122EE06

TWL black – K0122BB06
Triple lock – K0122EE07
Triple lock black – K0122BB07



Hot-forged light alloy oval carabiners designed to be used especially with pulleys, ascenders and descenders.

- hot-forged I-beam construction makes the carabiner extremely strong, stiff and light
- rough notches on the locking sleeve for easy manipulation
- angled snag free HYPERLINK „<http://www.singirock.com/Keylock>“ Keylock nose for smooth clipping and unclipping
- almost oval shape makes the carabiner easy to turn around in device’s attachment points, anchors or slings
- thanks to the oval shape, pulleys attached are loaded symmetrically
- large rope bearing area for better rope glide and reduced wear of the carabiner

- each carabiner is individually tested for a strength of 10 kN
- anodized finishing increases the corrosion resistance
- unique production number

Strength: \blacktriangleleft 26 \blacktriangleright 8 \square 7 kN
Gate opening (d): 21 mm
Weight:
Screw: 74 g • 2.61 oz
TWL/Triple lock: 81 g • 2.86 oz
CE1019 • EN 12275 • EN 362

OXY BC / SCREW, OXY BC / TWL
OXY BC / TRIPLE LOCK

Screw – K0123EC05
Screw black – K0123BC05
TWL – K0123EC06

TWL black – K0123BC06
Triple lock – K0123EC07
Triple lock black – K0123BC07



Hot-forged light alloy oval carabiner with a removable captive bar.

- captive bar keeps the carabiner in its proper orientation
- the bar is easily removable with an Allen key no. 2
- this carabiner keeps your equipment well-arranged and minimizes the chance of cross loading
- missing captive bar does not affect the strength of the carabiner and it is allowed to use the carabiner without a bar
- serial unique number for better traceability and inspection

Strength: \blacktriangleleft 26 \blacktriangleright 8 \square 7 kN
Gate opening (d): 21 mm
Weight:
Screw: 76 g • 2.68 oz
TWL/Triple lock: 83 g • 2.93 oz
CE1019 • EN 12275 • EN 362



OZONE / SCREW

K0016AA00
black matt – K0016BB00



Oval carabiner, key lock, screw gate
 ◀▶ 26 kN ⚡ 10 kN ◻ 7 kN
 gate opening (d): 21 mm
 unique production number
 80 g • 2.82 oz
 € 1019 • EN 362 • EN 12275



OZONE / TWL

K0017AA00
black matt – K0017BB00



Oval carabiner, key lock, twist lock
 ◀▶ 26 kN ⚡ 9 kN ◻ 7 kN
 gate opening (d): 21 mm
 unique production number
 85 g • 3 oz
 € 1019 • EN 362 • EN 12275



OZONE / TRIPLE LOCK

K0018AA00
black matt – K0018BB00



Oval carabiner, key lock, triple lock
 ◀▶ 26 kN ⚡ 9 kN ◻ 7 kN
 gate opening (d): 21 mm
 unique production number
 85 g • 3 oz
 € 1019 • EN 362 • EN 12275



Ozone carabiners / Ozone has been designed to be used with pulleys, ascenders and descenders: its almost oval shape makes the carabiner easy to turn around in slings or belay station.



Grimp Day competition, Belgium, Photo: Michal Šafus

MAILLON MINI OVAL

K82006Z



D 6 mm • 4 kN
gate opening 7,5 mm
zinc-plated • 33 g

MAILLON SMALL OVAL

K82008Z



D 8 mm • 35 kN
gate opening 11 mm
zinc-plated • 77 g
CE 0082 • EN 12275
• EN 362 • UAA

MAILLON SMALL DELTA

K82207Z



D 7 mm • 4 kN
gate opening 8,5 mm
zinc-plated • 58 g

MAILLON BIG DELTA

K82210Z



D 10 mm • 45 kN
gate opening 12 mm
zinc-plated • 153 g
CE 0082 • EN 12275
• EN 362 • UAA

MAILLON BIG D

K82310Z



D 10 mm • 45 kN
gate opening 10 mm
zinc-plated • 153 g
CE 0082 • EN 12275
• EN 362 • UAA

BIG SQUARE

K82410Z



D 10 mm • 45 kN
gate opening 12 mm
zinc-plated • 166 g • 5,86 oz
CE 0082 • EN 12275
• EN 362 • UAA

BIG TWIST

K82508Z



D 8 mm • 32 kN
gate opening 17,5 mm
zinc-plated • 106 g • 3,74 oz
CE 0082 • EN 12275
• EN 362 • UAA

SMALL CONNECTOR

K3702PP
steel - K3690ZO



Small connector with double trigger
automatic locking
gate opening 21 mm • 25 kN
polished, Al • 150 g • 5,29 oz
unique production number
CE 0333 • EN 362

D STEEL / SCREW

K4080ZO



D steel connector / screw
with screw gate, key lock, zinc plated
◀ 50 kN ▲ 13 kN ◻ 20 kN
gate opening (d) 25 mm • 255 g • 9 oz
unique production number
€ 1019 • EN 362

D STEEL / TRIPLE LOCK

K4081ZO



D steel connector / triplelock
with triplelock gate, key lock, zinc plated
◀ 50 kN ▲ 13 kN ◻ 20 kN
gate opening (d) 25 mm • 267 g • 9 oz
unique production number
€ 1019 • EN 362

OVAL STEEL / TRIPLE LOCK

K4241ZO07



Oval steel connector / triplelock
with key lock and triplelock gate
◀ 30 kN ▲ 9 kN ◻ 8 kN
gate opening (d) 18 mm • 195 g • 6.9 oz
unique production number
€ 1019, EN 362

PALM CONNECTOR

yellow – K0124SY09
grey – K0124ST09

NEW



Light alloy double action carabiner designed to be used especially on Via Ferrata routes, also certified as an industrial termination connector.

- hot forged gate
- double action opening system
- wear indicator shows when to retire the carabiner from use
- anodized finishing increases corrosion resistance
- carabiner is available in two color versions (with yellow or grey gate)
- each carabiner is individually tested for a strength of 10 kN
- unique serial number

OVAL STEEL / SCREW

K4241ZO05



Oval steel connector / screw
with screw gate, key lock, zinc-plated
◀ 30 kN ▲ 9 kN ◻ 8 kN
gate opening (d) 18 mm
176 g • 6,21 oz
unique production number
€ 1019 • EN 362

Weight: 117 g / 4.1 oz
Material: aluminum alloy, plastic, stainless steel
Strength major axis: 28 kN
Strength minor axis: 14 kN
Strength open gate: 7 kN
Gate opening (d): 28 mm
€ 1019 • EN 362/T • EN 12275/K

CONNECTOR GIGA

K3550PP00
black – K3550BB00



with double trigger
automatic locking
gate opening 110 mm • 25 kN
polished, Al • 965 g • 34.04 oz
unique production number
€ 0321 • EN 362

BIG CONNECTOR

K3536PP00
black – K3536BB00



with double trigger
automatic locking
gate opening 60 mm • 28 kN
polished, Al • 450 g • 15.87 oz
unique production number
€ 0321 • EN 362

PORTER

K9000BB03



Plastic holder for racking ice screws, pitons and industrial tools.

- for racking ice screws, pitons and industrial tools on the harness
- easy clipping and un-clipping
- the nose on the upper part allows to set away some stuff in order to access stuff on the bottom.
- rubber part fixes the Porter on place and prevent it from rotation

WARNING: NOT FOR CLIMBING!

The Porter is NOT load-bearing! It is not designed to hold human's weight. Do not use it for protection or belaying.

Gate opening: 23 mm

Max. load: 5 kg

Weight: 32 g • 1.13 oz



MINI PEAR

K5052EE00



accessory carabiners

mix colour • 16 g • 0.56 oz • gate opening (d) 11 mm

Not for climbing.

MINI D

K5182EE00



accessory carabiners

mix colour • 25 g • 0.88 oz • gate opening (d) 14 mm

Not for climbing.

MINI D SCREW

K0027BY00



accessory carabiners

black colour • 28 g • 1 oz

gate opening (d) 13 mm

3 kN

Not for climbing.

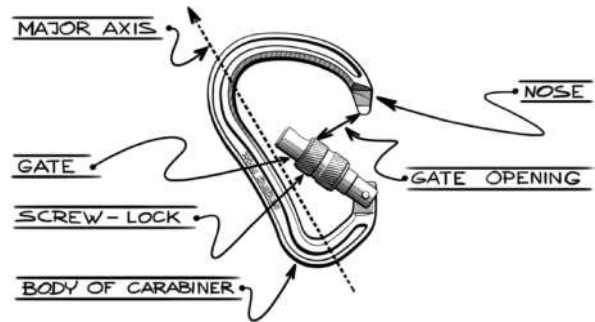
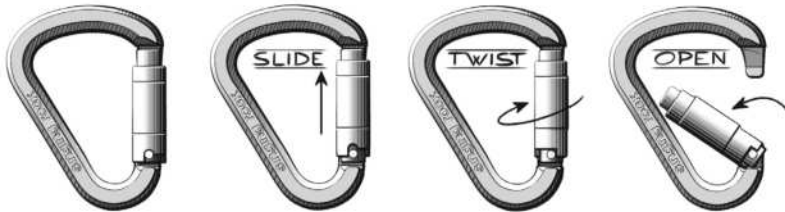
SCREW LOCK**TWL-TWIST LOCK****TRIPLE LOCK****GATE OPENING (d)**

TECHNOLOGY



KEYLOCK

for easy manipulation

Key lock is an extremely simple and ingenious locking system that solves the problems associated with the traditional design of carabiners. It eliminates any risk of ropes or slings becoming entangled in the gate or in the carabiner nose when it is being connected or released. Neither the gate, which is completely cylindrical, nor the nose has any sharp edges. Ropes and slings do not, therefore, come into the contact with any cutting edges.



HOT FORGING

the latest technology in manufacturing of light alloy hardware



























Aluminum alloy is heated state when being forged into the final shape. This allows the metal to be formed more easily so it can be moved to areas where it is needed and removed from the areas where it is not needed. In comparison with cold forged binners, the hot forged binners are lighter, more durable and stronger.































UNIQUE PRODUCTION NUMBER

identification of metal parts

For better traceability and inspection recording the Singing Rock metal parts are marked with the unique production number. Singing Rock metal parts marked with the unique production number are in this catalogue indicated with text "unique production number".

type	preview	code	colour / surface	material	EN12275 sport	EN362 work	↔ kN	⇄ kN	↻ kN	gate open. [mm]	weight [g]	oz
D STEEL / SCREW		K4080ZO	zinc-plated	steel	–	•	50	13	20	25	255	8.93
D STEEL / TRIPLE LOCK		K4081ZO	zinc-plated	steel	–	•	50	13	20	25	267	9.35
OVAL STEEL / SCREW		K4241ZO05	zinc-plated	steel	–	•	30	9	8	18	176	6.21
OVAL STEEL / TRIPLE LOCK		K4241ZO07	zinc-plated	steel	–	•	30	9	8	18	195	6.9
COLT / SCREW		K0112EE00	mix	AL alloy	•	•	26	8	11	18	48	1,7
COLT / SCREW BLACK		K0112BB00	black	AL alloy	•	•	26	8	11	18	48	1,7
COLT / STRAIGHT		K0111EE00	grey	AL alloy	•	–	26	8	11	21	42	1,5
COLT / STRAIGHT BLACK		K0111BB00	black	AL alloy	•	–	26	8	11	21	42	1,5
COLT / BENT		K0110EE00	yellow	AL alloy	•	–	26	8	11	21	42	1,5
COLT / BENT BLACK		K0110BB00	black	AL alloy	•	–	26	8	11	21	42	1,5
COLT / WIRE STRAIGHT		K0113EE00	silver	AL alloy	•	–	26	8	11	22	36	1,3
COLT / WIRE BENT		K0120EE00	blue	AL alloy	•	–	26	8	11	22	36	1,3
BORA / SCREW		K0107EE00	mix	AL alloy	•	•	23	8	8	22	63	2,2
BORA / SCREW BLACK		K0107BB00	black	AL alloy	•	•	23	8	8	22	63	2,2
BORA / TWL		K0108EE00	grey	AL alloy	•	•	23	8	8	22	68	2,4
BORA / TWL BLACK		K0108BB00	black	AL alloy	•	•	23	8	8	22	68	2,4
BORA / TRIPLE LOCK		K0119EE00	orange	AL alloy	•	•	23	8	8	22	68	2,4
BORA / TRIPLE LOCK BLACK		K0119BB00	black	AL alloy	•	•	23	8	8	22	68	2,4
BORA GP / SCREW		K0107EP00	grey	AL alloy	•	•	23	8	8	22	64	2,3
BORA GP / SCREW BLACK		K0107BP00	black	AL alloy	•	•	23	8	8	22	64	2,3
HECTOR / SCREW		K0114EE00	blue	AL alloy	•	•	30	9	8	26	83	2.9
		K0114BB00	black	AL alloy	•	•	30	9	8	26	83	2.9
HECTOR / TRIPLE LOCK		K0121EE00	blue	AL alloy	•	•	30	9	8	26	89	3.1
		K0121BB00	black	AL alloy	•	•	30	9	8	26	89	3.1
HECTOR BC / SCREW		K0114EC00	blue	AL alloy	•	•	30	9	8	26	85	3
		K0114BC00	black	AL alloy	•	•	30	9	8	26	85	3

HECTOR BC / TRIPLE		K012IEC00	blue	AL alloy	•	•	30	9	8	26	91	3.2
		K012IBC00	black	AL alloy	•	•	30	9	8	26	91	3.2
OXY SCREW		K0122EE05	golden	AL alloy	•	•	26	8	7	21	74	2.6
		K0122BB05	black	AL alloy	•	•	26	8	7	21	74	2.6
OXY TWL		K0122EE06	golden	AL alloy	•	•	26	8	7	21	81	2.9
		K0122BB06	black	AL alloy	•	•	26	8	7	21	81	2.9
OXY TRIPLE LOCK		K0122EE07	golden	AL alloy	•	•	26	8	7	21	81	2.9
		K0122BB07	black	AL alloy	•	•	26	8	7	21	81	2.9
OXY BC SCREW		K0123EC05	golden	AL alloy	•	•	26	8	7	21	76	2.7
		K0123BC05	black	AL alloy	•	•	26	8	7	21	76	2.7
OXY BC TWL		K0123EC06	golden	AL alloy	•	•	26	8	7	21	83	2.9
		K0123BC06	black	AL alloy	•	•	26	8	7	21	83	2.9
OXY BC TRIPLE LOCK		K0123EE07	golden	AL alloy	•	•	26	8	7	21	83	2.9
		K0123BB07	black	AL alloy	•	•	26	8	7	21	83	2.9
OZONE / SCREW		K0016AA00	blue	AL alloy	•	•	26	10	7	21	80	2.82
		K0016BB00	black	AL alloy	•	•	26	10	7	21	80	2.82
OZONE / TWL		K0017AA00	blue	AL alloy	•	•	26	9	7	21	85	3
		K0017BB00	black	AL alloy	•	•	26	9	7	21	85	3
OZONE / TRIPLE LOCK		K0018AA00	blue	AL alloy	•	•	26	9	7	21	85	3
		K0018BB00	black	AL alloy	•	•	26	9	7	21	85	3
SMALL CONNECTOR		K3702PP	silver	AL alloy	-	•	25			21	150	5.29
		K3690ZO	zinc-plated	steel	-	•	25			244	244	8.6
BIG CONNECTOR		K3536201	silver	AL alloy	-	•	28			60	450	15.87
		K3536BB00	black	AL alloy	-	•	28			60	450	15.87
GIGA CONNECTOR		K3550PP	silver	AL alloy	-	•	25			110	965	34.04
		K3550BB00	black	AL alloy	-	•	25			110	965	34.04
PALM CONNECTOR		K0124SY09	yellow	AL alloy	•	•	28	14	7	28	117	4.1
		K0124ST09	grey	AL alloy	•	•	28	14	7	28	117	4.1



HELMETS

WORK
SPORT



HELMETS



FLASH



Professional protective helmets designed with emphasis to comfortability and durability. Helmets are available in two models depending on the user's choice according the working situation.

- helmet construction with shock resistant ABS/PC shell and without EPS lining provides great ventilation and comfort for user
- fully adjustable headband with two side and two rear adjusting sleeves to regulate the length of the chin straps
- fast, easy and durable size adjustment mechanism on the back of the helmet with UNI size 53–63 cm
- suspension straps easily adjustable to 3 depth levels

- four head lamp holders for any head lamp available on the market
- inner padding fully removable and hand or machine washable at 30 °C (86 °F)
- helmets can be safely used in the temperatures ranging from –30 to +50 °C (–22 to 122 °F)
- universal 30 mm accessory slot is compatible with most of the visors and hearing protectors on the market
- certified with Hellberg safety ear muffs
- reflective stickers included
- unique number marking



Windows maintenance, Ostrava, Czech republic
Photo: Petr Piechowicz

FLASH INDUSTRY

red – W9601RX00
white – W9601WX00

yellow – W9601YX00
black – W9601BB00
high visible – W9601QX00



Professional safety helmet for industrial work and construction sites. Its main purpose is to protect the user against falling objects and voltage.

- safety chin strap in compliance with EN 397 is released at a load ranging between 15 and 25 daN (approx. 15–25 kg), which eliminates the risk of strangling
- suitable for working situations where, in case of fall, the risk of strangling is higher than risk of dropping the helmet
- fulfils EN 397 optional requirements: low temperature (–30°C), lateral deformation, electrical insulation (440V a.c.)
- five color variants
- fulfils side impact force requirements according to EN 12492

Weight: 455 g • 16.05 oz
Material: ABS/PC
Size: UNI (53–63 cm)
Color: yellow, white, red, black, high-visibility yellow
CE 1015 • EN 397 (LD, 440V a.c., –30 °C)

FLASH ACCESS

red – W9603RX00
high visible yellow – W9603QX00



Protective helmet for work at heights, working over free depth and rescue purposes. It is primarily intended for protection against falling objects and to protect against voltage.

- helmet has a solid chin strap that will withstand a load of at least 50 kg, which prevents the possibility of dropping the helmet in case of fall
- suitable for work at heights activities where, in case of fall, the risk of dropping the helmet is higher than risk of strangling
- combines the requirements of EN 397 and EN 12492
- fulfils EN 397 optional requirements: low temperature (–30°C), lateral deformation, electrical insulation (440V a.c.)

- fulfils side impact force requirements according to EN 12492

Weight: 455 g • 16.05 oz
Material: ABS/PC
Size: UNI (53–63 cm)
Color: red, high-visibility yellow
CE (LD, 440V a.c., –30 °C)
CE 1015

FLASH AERO

red – W9602RX00
high-visibility yellow – W9602QX00



Protective well ventilated helmet for work at heights, working over free depth and rescue purposes. Suitable for heavily physically working persons. Its main purpose is to protect the user against falling objects.

- helmet has a solid chin strap that will withstand a load of at least 50 kg, which prevents the possibility of dropping the helmet in case of fall
- suitable for work at heights activities where, in case of fall, the risk of dropping the helmet is higher than risk of strangling
- combines the requirements of EN 397 and EN 12492

- fulfils ventilation requirements according to EN 12492 which ensures better ventilation for heavily physically working persons and persons working in excessively warm environments

Weight: 455 g • 16.05 oz
Material: ABS/PC
Size: UNI (53–63 cm)
Colors: red, high-visibility yellow
CE

PENTA

blue – C0071AA00
red – C0071RR00

grey – C0071SS00
white – C0071WW00



Extremely lightweight, super-comfortable and fully ventilated climbing helmet. All this combined with a maximum head protection. For its comfort and lightweight design is ideal for sport climbing, mountaineering, trad climbing or via ferrata.

- Co-molded expanded polystyrene foam and hard polycarbonate shell engineered to ensure maximal head protection and still keep lightweight and low profile
- Narrow straps of retention system are very soft and light and do not press as standard hard-plastic headbands
- Soft (webbing made) rear adjustment system (headband) conforms better to the head and provides compact storage in the backpack
- Extended chin strap length allows to wear a hat under the helmet
- 4 headlamp clips are imbedded to avoid snagging, robust for easy handling and secure attachment of any headlamp on the market
- 11 vents and air channels built in the foam facilitate excellent ventilation
- Inside padding is fully removable and washable
- Available in 4 color versions

Weight: 205 g • 7.23 oz
Color: blue, grey, red, white
Size: UNI (51–60 cm)
CE • EN 12492 • 



PENTA
EXTREMELY LIGHTWEIGHT, SUPER-COMFORTABLE
AND FULLY VENTILATED SMART HELMET

MAXIMAL HEAD PROTECTION WITH
LIGHTWEIGHT AND LOW PROFILE COMOLDED
EPS AND HARD PC SHELL

11 VENTS FACILITATE EXCELLENT
VENTILATION

4 ROBUST HEADLAMP CLIPS TO SECURE
ANY HEADLAMP ON THE MARKET

FLEXIBLE REAR ADJUSTMENT SYSTEM
CONFORMS BETTER TO THE HEAD AND
PROVIDES COMPACT STORAGE

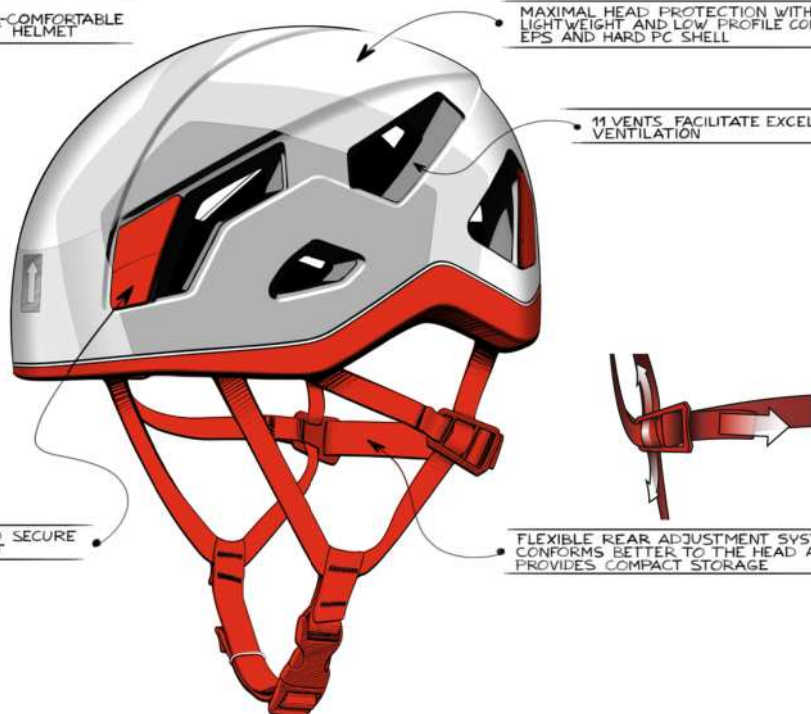

HELMETS

	Product name	code	color	head circumference (cm)	weight (g)	EN 397	EN 12492	CE						
	FLASH INDUSTRY	W9601	yellow, white, red, black, high-visibility yellow	53-63	455	•	—	CE 1015	15-25 kg	440V a.c.	—	-30 °C	•	•
	FLASH ACCESS	W9603	red, high visible yellow	53-63	455	—	—	CE 1015	min. 50 kg	440V a.c.	—	-30 °C	•	•
	FLASH AERO	W9602	red, high visible yellow	53-63	455	—	—	CE	min. 50 kg	—	•	-10 °C	—	•
	PENTA	C0071	blue, red, grey, white	51-60	205	—	•	CE	min. 50 kg	—	•	-10 °C	—	•

FLASH INDUSTRY
PROTECTIVE HELMET SUITABLE FOR INDUSTRIAL WORK AND CONSTRUCTION SITES

FOUR HEAD LAMP HOLDERS FOR ANY HEAD LAMP AVAILABLE ON THE MARKET

AREAS ALLOWED FOR REFLECTIVE STICKERS PLACEMENT

TWO SIDE AND REAR ADJUSTING SLEEVES TO REGULATE THE LENGTH OF THE CHIN STRAPS

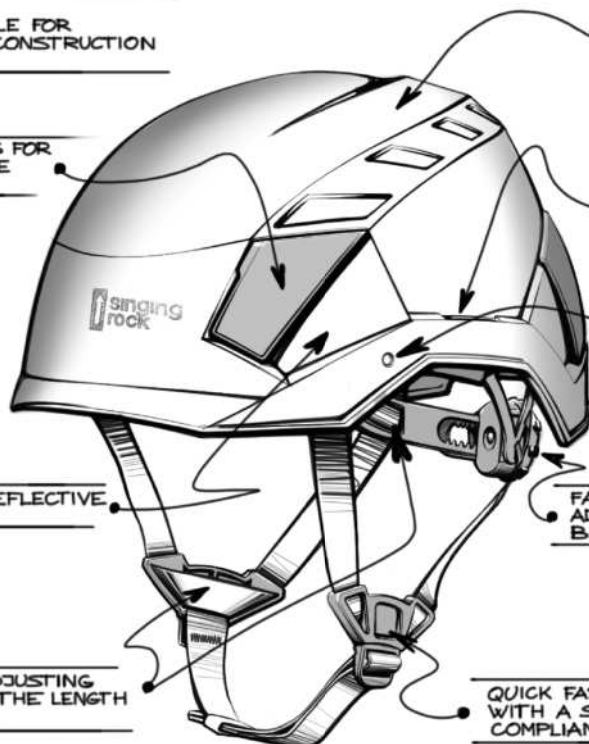

HIGH DENSITY AND SHOCK RESISTANT PC SHELL

SIDE SLOTS FOR HEARING PROTECTION

VISOR COMPATIBLE

FAST, EASY AND EFFECTIVE SIZE ADJUSTMENT MECHANISM ON THE BACK OF THE HELMET

QUICK FASTENING AND OPENING BUCKLE WITH A SAFETY RELEASE SYSTEM IN COMPLIANCE WITH EN 397

SAFE PC ELECTRIC ARC VISOR X0049XX00



Visor providing protection against electric arc up to 400 volts.

- approved to medium impact and suitable for electrical work
- visor is possible to attach with or without the earmuffs
- for attaching to the FLASH helmet SAFE 2 FLEX CARRIER and SECURE earmuffs or CLASSIC ADAPTOR are needed

Material: PC
Length: 200mm • Weight: 116g
Thickness: 1,5mm
CE EN 166/1B389 • EN 170/2-1,2

SAFE NYLON MESH VISOR X0051XX00



Light weight and non-conductive visor which stays close to your face for great coverage.

- gives a comfortable airflow
- approved to low impact
- visor is possible to attach with or without the earmuffs
- for attaching to the FLASH helmet SAFE 2 FLEX CARRIER and SECURE earmuffs or CLASSIC ADAPTOR are needed

Light transmission 58–61%
Length: 185mm
Weight: 36g
CE EN 1731/F ANSI Z87

CLASSIC ADAPTOR (PAIR) X0053XX00



Allows attachment of the flex carrier for face shield without earmuffs.

- compatible with Flash helmets
- sold in pair

SAFE 2 FLEX CARRIER X0052XX00



Intended for attachment of the visors to helmet using earmuffs or adaptors.

- Compatible with Flash helmets.

CE EN 166/1731 ANSI Z87+

FLASH PADDING W9604XX00



Replacement foam padding for FLASH helmets.

- easy maintenance and replacing the padding

Weight: 6g • Material: PE

COVER

W9605XX00



Protective eye shield suitable for industrial work and construction sites. Its main purpose is to protect the user against fast-moving particles.

- durable positioning mechanism with two positions
- knurled screw for easy manipulation
- robust shield body with excellent optical performance area with anti scratch film
- fulfills EN 166 / 1 / F (I - First optical quality
- F - Increased resistance against fast flying particles)
- shield is clear and do not have any protection against UV radiation

- compatible with the Singing Rock FLASH helmet family. Cannot be used separately or with another helmets.

Height: 100 mm
 Thickness: 2.25 mm
 Material: PC
 Weight: 100 g • 3.5 oz



1 C - X0048XX25
 2 C - X0048XX29
 3 C - X0048XX31

SECURE EARMUFFS



SECURE EARMUFFS 1C

The cap mounted earmuff is the ideal choice for any work that requires head and hearing protection.

- durable construction withstands rough environments
- slim design reduces the risk of snagging in confined areas
- available in three protection levels, clearly indicated with bright safety colours for easy identification and selection
- fully compatible with Safe Visor System
- universal 30 mm euro slot adaptor is compatible with most helmets on the market
- non-conductive
- smooth telescopic size adjustment
- certified with Flash helmets

Size: UNI
 Weight: 250 g
 SNR: 25 • NRR: 22 • SLC (80): 25
 Suitable for: construction sites, engineering, forestry work, agriculture, mining
 CE EN 352-3:2002

SECURE EARMUFFS 2C

Great choice for long term use in middle noise environment or for shorter use with high noise level.

The best choice for high frequency noise.
 Weight: 271 g
 NRR: 24 • SLC (80): 28
 Suitable for: construction sites, engineering, forestry work, agriculture, mining
 CE EN 352-3:2002

SECURE EARMUFFS 3C

Earmuffs suitable for extremely high noise environment.

The best choice for low oscillation frequency.

Weight: 300 g
 SNR: 31 • NRR: 27 • SLC (80): 31
 Suitable for: mining, car racing
 CE EN 352-3:2002



HARDWARE

- ANCHOR AND BELAY DEVICES
- ASCENDERS
- DESCENDERS
- PULLEYS
- SELF BRAKING DEVICES
- RETRACTABLE
- FALL ARRESTERS



SIR 

K032SIR00



Robust multifunctionality device for use in industrial rope access. Its functionality spans the range from rope descender and abseiling device through fall-arrest device to work positioning device for use on roofs and edges.

- unimpeded movement of the cam
- by pulling onto the working end of the rope the cam engages and jams the rope
- by pulling the lever the cam gradually releases the rope. If the lever is pulled down to its terminal position the double-stop function is triggered which blocks the rope again
- spring loaded pin for impeded swinging of the cam
- easy and intuitive installation of the device onto the rope. (watch the pictograms and read the instruction of use)
- no hidden mechanisms for easy inspection
- metal lever under all industrial conditions tested for 225 Kg according to EN 12841(rope access)

Weight: 365g • 12.88 oz
 Rope diameter: 10–12 mm
 Working load: 225 kg

EN 341-A Singing Rock static rope
 R 44 11 mm
 EN 12841-C static rope 10–12 mm
 CE 0123 • EN 358 • EN 795 Type B

DOUBLE STOP PLUS 

K031DSD00



Descender with double locking and self-braking anti-panic system in case of accidental loss of descent control.

- the descender doesn't have movable flanges. This makes it a robust and mistake-resilient device (quick insertion and release, no need to unclip it for rope insertion)
- new cam tested for higher loads – enhanced braking in both stop positions
- unique way of rope insertion. Diminished possibility of incorrect insertion of the rope. Even incorrect insertions will not result in a fall as the rope is blocked.
- sensitive and longer handle enables smooth descent without harmful rope twisting, gentle and progressive braking (enhanced press stop braking mode)
- rubberized handle provides pleasant feeling, non slip and thermal insulation.
- ergonomically improved curved edges and longer flanges provide the user with a comfortable grip with the handle
- integrated wear indicator
- high strength plain bearing added to the pivoting cam

- all parts in contact with the rope are made of stainless steel – minimum possible wear
- rope diameter: 9–12 mm
 9 mm – max. rated load 130 kg
 10–12 mm – max. rated load 200 kg

Weight: 421g • 14.85 oz • Breaking loads in excess of 22 kN.
 Increased maximum rated load to 200 kg.
 Reduced slippage of the rope to 600 daN.
 Reduced force required on the handle.
 CE 0123 • EN 12841 Type C

INDY EVO PLUS

K0101BX00



Manually operated descender device with double auto-locking system, that locks both when the lever is released or when it is pressed.

INDY EVO is also a descender device (conform to EN 12841 type C) for working rope and it allows a descent at a controlled speed and stop at any time, hands free, on a static rope (EN 1891) or dynamic rope (EN 892).

It allows the lowering of two people at the same time.

Dimensions: 212x58x38 mm
 Weight: 480 g • 16.9 oz
 Rope Ø 10-12 mm (100 kg)
 Rope Ø 11-12 mm (200 kg)
 NFPA 1983 (2012 ED)
 Rope Ø 10-13 mm (one person only)
 CE 0426 • EN 341 • EN 12841



RAMA

grey – K0043SX00
 orange – K0043OX00



Intuitive single rope belay device with enhanced braking feature. Designed for gym or single pitch sport climbing.

- reliable locking geometry provides added level of safety to your belay
- operating is very simple, as it works without any moving parts or lever
- large clipping area for most common carabiner shapes, works best with BORA or OXY carabiner
- durable stainless steel braking surface provides longer lifetime and the smooth and secure control for gradual lowering
- functionality is according to the tube principle and is therefore suitable for lead and top-rope climbing
- compact geometry makes paying out rope even faster and easier, while the handle has a comfortable and firm grip.

Weight: 84 g • 3 oz
 Rope diameter: 8.7 – 11 mm
 Material: Light alloy, steel, plastic
 EN 15151-2



RAMA SET

M0201XX00

Single rope belay device with enhanced braking feature and hot-forged light alloy oval carabiner OXY TWL create a perfect set for lead or top-rope climbing.

Weight: 165 g • 5.82 oz
 Rope diameter: 8.7 – 11 mm
 Material: Light alloy, steel, plastic

SHUTTLE

K6140EE00
black matt – K6140BB00



Belay and rappel device

One device to do it all, the Shuttle offers maximum versatility. It has a groove, designed and shaped to provide equal friction for both thin and thick ropes.

When you're belaying from above, the "guide mode" lets you bring up one or two seconding climbers under control. For lowering, it has a small secondary hole that you can clinch carabiner or sling to release the device.

- designed for twin, half and single ropes
- lightweight and compact
- V-grooves for high friction when belaying the leader or rappeling
- only 65g – one of the lightest belay devices on the market
- self locking function when belaying the second
- eye for releasing the weight
- possibility of simultaneous belaying two climbers
- weight: 65g • 2.29 oz
- material: light alloy

Rope diameter:
 ①/2 7,8 – 10,5 mm
 ① 9 – 10,5 mm
 EN 15151-2



BUDDY

K6132EE
black matt – K6132BB



Light and compact belay tube.

For all-round climbers.
 Designed for ropes 7,8 – 11 mm
 mix color • 54g • 1.91 oz

EN 15151-2



FIGURE 8L

K6031EE
black matt – K6031BB



Designed for ropes of bigger diameters.

30 kN • color mix • light alloy • 125 g • 4.41 oz

- for ropes of various diameters
- easy rappelling
- effective heat distribution

EN 15151-2

FIGURE 8M

K6021EE
black matt – K6021BB



Designed for ropes of smaller diameters.

25 kN • color mix • light alloy • 104 g • 3.67 oz

EN 15151-2

RESCUE FIGURE EIGHT

stainless steel – K6180ZO
light alloy, black matt – K6180BB



Special figure eight for the rescue situations and fast rappelling

40 kN

material:

stainless steel, light alloy

weight:

steel 451 g • 15.9 oz, light alloy 154 g • 5.43 oz

LIFT

 LEFT – RK804BX0L
 RIGHT – RK804BX0R

LIFT open

Hand ascender for safe and smooth ascent. Extra wide handle and attachment point for two carabiners will fit everyone from bigwall climbers to workers at height or special forces.

- available in two variants – for left and right hand
- stainless steel toothed cam for higher corrosion resistance and for any conditions (frozen or dirty ropes)
- overmolded grip and ergonomic upper part for a comfortable and powerful grip
- wide lower hole allows to connect two standard carabiners
- upper hole for clipping a carabiner around the rope
- trigger with a short descent feature

Weight: 190 g • 6.7 oz
 Material:
 body – light alloy
 cam – stainless steel
 trigger – plastic

EN 12841 Static rope Ø 10–13 mm
 EN 567 Rope Ø 8–13 mm
 CE 1019 • EN 567 • EN 12841 type B

CAM CLEAN

RK805BX00



Compact and lightweight chest ascender for safe and smooth rope ascent, rescue and special rope techniques.

- simple and quick manipulation
- lower hole angled to keep flat position on the harness
- stainless steel toothed cam for higher corrosion resistance and for any conditions (frozen or dirty ropes)
- Upper hole for attaching a PULLER shoulder strap to keep the rope clamp in a correct position
- trigger with a short descent feature

Weight: 125 g • 4.4 oz
 Material:
 body – light alloy
 cam – stainless steel
 trigger – plastic

EN 12841 Static rope Ø 10–13 mm
 EN 567 Rope Ø 8–13 mm
 CE 1019 • EN 567 • EN12841 type B

STRAP FOR CAM CLEAN

W0085BB00



Strap for CAM CLEAN attachment to full body harnesses including plastic cover on the carabiner.

Weight: 15 g • 0.53 oz

PULLER

S1100BY

**Accessory webbing for chest ascender fixation**

- fixes chest ascender in right position
- fixed by accessory sling or a mailon carabiner to front/back
- attachment point on the harness

Color: black
Size: UNI
Width: 25 mm



LOCKER

W1010BB09

**Guided type fall arrester and work positioning device for 11 mm textile ropes (recommended Singing Rock Static 11).**

- Construction of the device allows to release it even when it is loaded
- parking cam for blocking in required position
- unopenable version together with 11 mm sewn-in rope available as SITE – work positioning lanyard
- unique production number

Color: black matt
Weight: 240 g • 8.5 oz
CE 1019 • EN 353-2 • EN 358 • EN 12841

LOCKER SLING

W1015B020

**Certified sling for connection the LOCKER with your harness**

Length: 20 cm • Width: 20 mm
Strength: 22 kN

CE 1019 • EN 354 • EN 566

BACK-UP

K04000BB

**Fall arrester that follows the user in both directions and stops the possible fall**

- safe and simple to use with one hand only
- shifting the special button on the lock mode, it can be used also as a positioning device or a normal locking device
- supports also the strongest stress in semi dynamic way and it avoids the shocking effects on the ropes caused by the traditional self-locking devices with toothed cams

- connector included
- it can be used also as a positioning device or a normal locking device by shifting the special button on the lock mode.

Weight: 205 g • 7.23 oz (without connector),
420 g • 14.82 oz (connector included)
Rope diameter: 10-12 mm
EN 353-2 • EN 358 • EN 567 • EN 12841 A/B
CE 0426

PULLEY TWIN

RK802EE00
black version – RK802BB00



Large double pulley for textile ropes for those who need great hauling efficiency, durability and still lightweight pulley.

- designed and optimized for use with a Prusik friction knot or any clamps
- sealed ball bearing and large diameter of the sheave provides great efficiency 94%
- top attachment point accepts up to three carabiners
- durable and lightweight high-efficiency single pulley for industrial use and hauling systems
- formed side plates provides protection of rope against contact with a surrounding
- fixed-by-forging sheave and anti dust cover of ball bearing provides great lifespan

- side plate holes enable cleaning of the ball-bearing surrounding

bottom attachment point: 12 kN
strength: 36 kN
working load: 4x3 kN
max. Ø rope: 13 mm
static and dynamic ropes
sheave: aluminium alloy
side plates: aluminium alloy
sealed ball bearing: steel
axle: stainless steel
weight: 421 g • 14.9 oz
unique production number
CE 1019 • EN 12278

PULLEY EXTRA

RK801EE00
black version – RK801BB00



Large single pulley for textile ropes for those who need great hauling efficiency, durability and lightweight pulley.

- durable and lightweight high-efficiency single pulley for industrial use and hauling systems
- sealed ball bearing and large diameter of the sheave provides great efficiency 94%
- designed and optimized for use with a Prusik friction knot or any clamps
- top attachment point accepts up to three carabiners
- formed side plates provides protection of rope against contact with a surrounding
- fixed-by-forging sheave and anti dust cover of ball bearing provides great lifespan

- side plate holes enable cleaning of the ball-bearing surrounding

strength: 32 kN
working load: 2x3 kN
max. Ø rope: 13 mm
static and dynamic ropes
sheave: aluminium alloy
side plates: aluminium alloy
sealed ball bearing: steel
axle: stainless steel
weight: 257 g • 9.1 oz
unique production number
CE 1019 • EN 12278

TANDEM PULLEY

RK803BB00



Double pulley for Tyrolean traverses and zip-lines with two stainless steel sheaves for both textile ropes (13 mm) and steel wire cables (12 mm).

Each sheave is equipped with a pair of sealed ball bearings for great durability. Hard aluminium alloy body is black anodized and protects the sheaves from damage. Large attachment point can accommodate up to three carabiners.

Second attachment point for back-up carabiner or tackle systems building.

strength: 25 kN
max. Ø rope: 13 mm
static and dynamic ropes
12 mm steel cable
Sheave: stainless steel
side plates: aluminium alloy
sealed ball bearing: steel
axle: stainless steel
weight: 290 g • 10.2 oz
unique production number

CE 1019 • EN 12278

PULLEY SMALL RK800EE00
black version – RK800BB00

Small pulley for textile ropes for those who occasionally need to build simple hauling systems or manipulate with the objects.

- lightweight single pulley for hauling and rescue
- brass self lubricating bearing ensures reliable efficiency up to 81%
- suitable for use with a Prusik friction knot

strength: 22 kN
max. \varnothing rope: 13 mm
static and dynamic ropes
sheave: aluminium alloy
side plates: aluminium alloy
axle: stainless steel
friction bearing: brass
weight: 92 g • 3.3 oz
unique production number
CE 1019 • EN 12278

PULLEY MIKY

RK806BB00

NEW

Lightweight pulley with two attachment holes Designed for tree climbing application. Suitable for use with Prusik friction knot.

- two attachment holes with strength 28 kN
- anodized aluminum alloy side plates
- aluminum alloy sheave for textile ropes and auxiliary cords up to 13 mm in diameter
- bronze self lubricating bearing ensures reliable efficiency up to 81%
- unique production number marking

Weight: 105 g (3.7 oz) Material: sheave and side plates - aluminium alloy, bearing - bronze, axle - stainless steel
Strength: 28 kN
Max. diameter of rope: 13 mm
Bearing: friction
CE 1019, EN 12278

EASY LIFT

K0004BB



Rescue pulley for evacuation along the ski lift cable.

- intended to connect directly on the carrying steel cable of the ski lift
- designed for evacuation of a person during the ski lift rescue

Weight: 1.5 kg
Strength: 30 kN
Max. diameter of steel rope: 55 mm
Max. speed: 2 m/s
Working load: max. 5 kN
Sheave: PA
Material: light alloy, PA, stainless steel

ATTENTION!

- never use pulley alone – always use together with back-up lanyard
- never use without braking rope

For better traceability and inspection this part is marked with the unique production number.

CE 1017

STAINLESS HANGER PLATE / WITH BOLT

10 mm RK702XX10
12 mm RK702XX12

10 mm w/bolt RK715XX10
12 mm w/bolt RK715XX12



Stainless steel hanger plates and bolts for permanent anchor points. Available in two different bolt sizes.

- recommended for outdoor, wet environment. Not recommended for aggressive environment (e.g. sea water, chlorinated pool water, chemically polluted environment, etc.)

Plate thickness: 3 mm
Bolt length: 84 mm
Length of the hole: 75 mm
Strength: 25 kN
Weight:
Hanger plate 42 g • 1.48 oz
10 mm w/bolt 112 g • 3.95 oz
12 mm w/bolt 140 g • 4.94 oz
EN 795 • EN 959

10 mm RK704XX10
12 mm RK704XX12

ZINC PLATED HANGER PLATE / WITH BOLT

10 mm w/bolt RK716XX10
12 mm w/bolt RK716XX12



Zinc plated steel hanger plates and bolts for permanent anchor points. Available in two different bolt sizes.

- recommended for indoor, dry environment

Plate thickness: 4 mm
Bolt length: 84 mm
Length of the hole: 75 mm
Strength: 25 kN
Weight:
Hanger plate 62 g • 2.19 oz
10 mm w/bolt 100 g • 3.53 oz
12 mm w/bolt 125 g • 4.41 oz
EN 795 • EN 959

GLUE IN ANCHOR

RK703XX10



Stainless steel durable permanent anchor point.

- works also in soft or pocketed stone
- smooth eye allows safe rope threading for retreat
- made of welded, grade AISI 316 stainless steel
- for drilled hole with diameter 12 mm
- recommended glue: UPM 44 or FIS 360V, resin capsule RM10

Diameter: 10 mm
Length of shaft: 80 mm
Weight: 120 g 3.18 oz
Strength: ◀ 30 kN ▶ 25 kN
EN 959 • EN 795 Type A

D – MOBILE

A0002SS01



Door or window anchor point

- an indispensable anchor point protect against sudden falls
- the safety traverse offers in connection with the rope perfect safety solution when working in wall openings and on balcony support plates
- no tools are needed to fix the traverse in doorways, the opening of which may be up to 1100 mm wide for one person for two persons can be maximum opening up to 900 mm

- fast adjustment by pressing the pawl
- star grip to clamp the safety traverse
- bearing surfaces coated with synthetic material

Strength: 22 kN • Weight: 11 kg
Dimensions: 141 x 13 x 13 cm
CE 0123 • EN 795 Type B

PILOT

X0070XX34



Removable anchors, developed both for fall protection and multi-use, are safe, lightweight, and simple to employ.

- tested to meet ANSI Z359.1 and EN 795
- easy to use, simply drill the proper size hole into your concrete or rock surface, blow the dust out with compressed air, and insert the unit
- multi-directional attributes, anchors work in horizontal, vertical and overhead surfaces

- easily reusable, when your job is done, simply fill in the drilled hole if necessary and reuse at your new desired location
- removable anchors can be used in construction and industrial fields, mining, and mountaineering as well
- suitable for the drilled holes in a diameter 20 mm

Weight: 200 g • Working load: 181 kg
 Size: 3/4" • Strength: 22 kN
 ANSI Z359.1 • EN 795 Type B • CE 0321

BANTAM BEAMER

X0075XX14



Designed for fall protection and rope access work positioning.

- lighter, smoother, and easier to use
- constructed with lightweight aircraft aluminum bars and 360° swivel D-Ring connections
- the clamps attach without tools to construction girders either overhead or underfoot

Weight: 1600 g • Spacing: 76,5 – 305 mm
 Working load: 181 kg • Strength: 22kN
 ANSI Z359.1 • EN 795 • CE

SNAKE BRACE

S 300 – W2018Y030
 S 600 – W2018A060

S 900 – W2018R090
 S 1200 – W2018B120
 M 300 – W2019Y030

M 600 – W2019A060
 M 900 – W2019R090
 M 1200 – W2019B120



Anchor point for through holes, designed to function as a link between the structure and the fall arrest, work positioning, rope access or rescue systems.

- intended for through holes whose minimum and maximum diameter corresponds to the type of Snake Brace in relation to the actual thickness of the current structure
- the opening need not be entirely regular but the minimum diameter must be flat. There must be a minimum space for installation behind the hole
- intended for a single user
- the maximum strength can be used only if the structure in which the anchor hole is located can withstand the load in all directions
- the minimum strength of the construction should be designed according to EN 795 (if not in accordance with EN 795, the load bearing capacity may be reduced)

- Snake Brace can be loaded in any direction only if also allowed by the construction in which is anchored
- can be used only with compatible connectors with locking mechanisms according to EN 362

Strength: 18 kN
 Length: 30, 60, 90, 120 cm
 Weight: (S 300) 162 g • 5.71 oz /
 (M 300) 395 g • 13.93 oz
 Material: S – dyneema, alloy, steel /
 M – PAD, alloy, steel
 CE 1019 • EN 795 Type B

type	strength	hole Ø min. (mm)	construction thickness (mm)						min. open space behind the hole (mm)
			>5	≥ 50	≥ 100	≥ 150	≥ 200	≥ 300	
			hole Ø max. (mm)						
S	18 kN	17,7	50	65	75	80	85	90	≥ 200
M	18 kN	22	175	195	210	225	235	255	≥ 450

RIGGING PLATE 3/5

RK714BB00



Aluminium alloy device for multi-point anchoring.

- provides efficient force distribution at different load directions
- low profile of the plate makes the connection as short as possible
- provides plenty of attachment holes
- rounded holes allow direct attachment of the ropes and slings to the rigging plate
- all attachment points are big enough to allow locking sleeves of most carabiners passing through

Weight: 145 g • 5.1 oz
Material: light alloy
Strength: 50 kN • Thickness: 8 mm
CE 1019

RIGGING PLATE 1/3

RK713BB00



Aluminium alloy device for multi-point anchoring.

- helps to organize carabiners at the anchor point
- provides efficient force distribution at different load directions
- rounded holes allow direct attachment of ropes and slings to the rigging plate
- central attachment point can accommodate up to three carabiners

- all attachment points are big enough to allow locking sleeves of most carabiners passing through

Weight: 65 g • 2.3 oz
Material: light alloy
Strength: 36 kN • Thickness: 6 mm
CE 1019

REDBLOCK

K0006RP00



Anchor device, that extends lifetime of the rope when top roping

- ideal partner for adventure parks, rope courses and climbing gyms
- allows to be installed in two axes
- for better traceability and inspection recording the RedBlock is marked with the unique production number

Color: red
Weight: 375 g • 13.23 oz
Material: stainless steel
Sheave: light alloy
Max. diameter of rope: 12 mm
Strength: 26 kN
CE 1019

TWISTER

K0030OG00



Innovated rotating anchor

Placed between a load and either rope or cable, the twister avoids severe rope twisting while the load turns.

Working load: 4 kN
Color: anthracite / yellow
Strength: 22 kN
Weight: 91 g • 3.25 oz
CE 0321 • EN 354

SITE

200 cm – W1011WB02
400 cm – W1011WB04

200 cm + K370 – W1012WB02
400 cm + K370 – W1012WB04



The work positioning lanyard with great handling makes your work safe and efficient.

- 11 mm rope sewn-in unopenable version of LOCKER – rope clamp (fall arrester)
- rope covered with tubular webbing
- parking cam for blocking in required position
- also available with stitched-in connector in accordance with EN 362 (K370)

Weight: 560 g (with connector), 410 g (without connector)

Length: 200 cm, 400 cm

CE 1019 • EN 358 • EN 353-2

SITE LANYARD

200 cm – W1014WB02
400 cm – W1014WB04



Certified lanyard with LOCKER fall arrester in accordance to EN 353-2 and EN 358.

- suitable only with LOCKER for creating your positioning lanyard



Weather and emergency station installation, Norway Photo: Pavel Nesvadba

RETRACTABLE TYPE FALL ARRESTERS:

This part of your safety system allows you to move freely within a certain distance during your work and absorbs the impact in the event of a fall. All devices are certified according to EN 360:2002, some of them are suitable for rescue purposes according to EN 1496:2007. SRL (self-retracting lanyard) devices are self-retractable, while winches are manually operated.

INOS line is an economical solution for light use consisting of 4 models of SRLs with most common length of wire rope or webbing lifeline – 3,5m, 6m, 10m, 20m. Each package includes an accessory cord for lowering the connector of the devices. INOS line is possible to use only for vertical fall arrest. It is an ideal device for scaffolds, ladders and pylons.

IKAR line is an ultimate hi-end range with a variety of solutions to cover all possible needs. These sturdy, low-maintenance height safety devices with webbing or galvanized steel lifeline are offered mainly in aluminium case featuring a rotational attachment swivel to better ergonomics and long lifetime. IKAR devices function in any location position and have been tested in a simulated fall trial over an edge according to CNB 11.060 2008 sharp edge type A (with exception of HRA series). Connectors incorporate a fall indicator for easier inspection.

INOS 3.5

W1501XX03



Retractable fall arrester in aluminum case.

- Compact size and light weight. Strong attachment point
- Polyester webbing with a width 25 mm and a length of 3.5 m.
- Working load 140 kg. Strength limit: 15 kN



INOS accessory cord

Accessory cord length: 4.1 m
 Weight: 1,9 kg • 4.2 lb
 € € 0120, EN 360:2002

INOS 6N

W1502XX06



Retractable fall arrest system in plastic case made of ABS. High impact resistance and long lifetime.

- Oval design for easy grip. Strong attachment point
- Polyester webbing with a width 20 mm and a length of 6 m.
- Working load 140 kg. Strength limit: 15 kN

Accessory cord length: 6.6 m
 Weight: 2,1 kg • 4.63 lb
 € € 0120 • EN 360:2002
 € € 0598

IKAR HWB 

IKAR HWB 1.8 – A4000W018

IKAR HWB 2,8 – A4000W028

IKAR HWB 3.5 – A4000W035



Retractable fall arrester with webbing lifeline and built-in shock absorber featuring rotating attachment point and double action connector.

- lightweight aluminium housing with a webbing lifeline
- swivel eye attachment point
- sewn in load indicator on lifeline
- additional testing against falls over edges ($r \geq 0,5\text{mm}$)
- steel double action hook on end of lifeline
- device can be attached to an anchorage point or safety harness

- HWB 1.8 can be used as protection against falls in working cages of lifting platforms under specific conditions

Weight: 0.7 kg / 0.8 kg / 1.1 kg

Length: 1.8 m / 2.8 m / 3.5 m

Working load: 136 kg

CE 0229, EN 360, ANSI / ASSE Z359.1-2007, ANSI / ASSE Z359.14-2014, CSA Z259.2.2

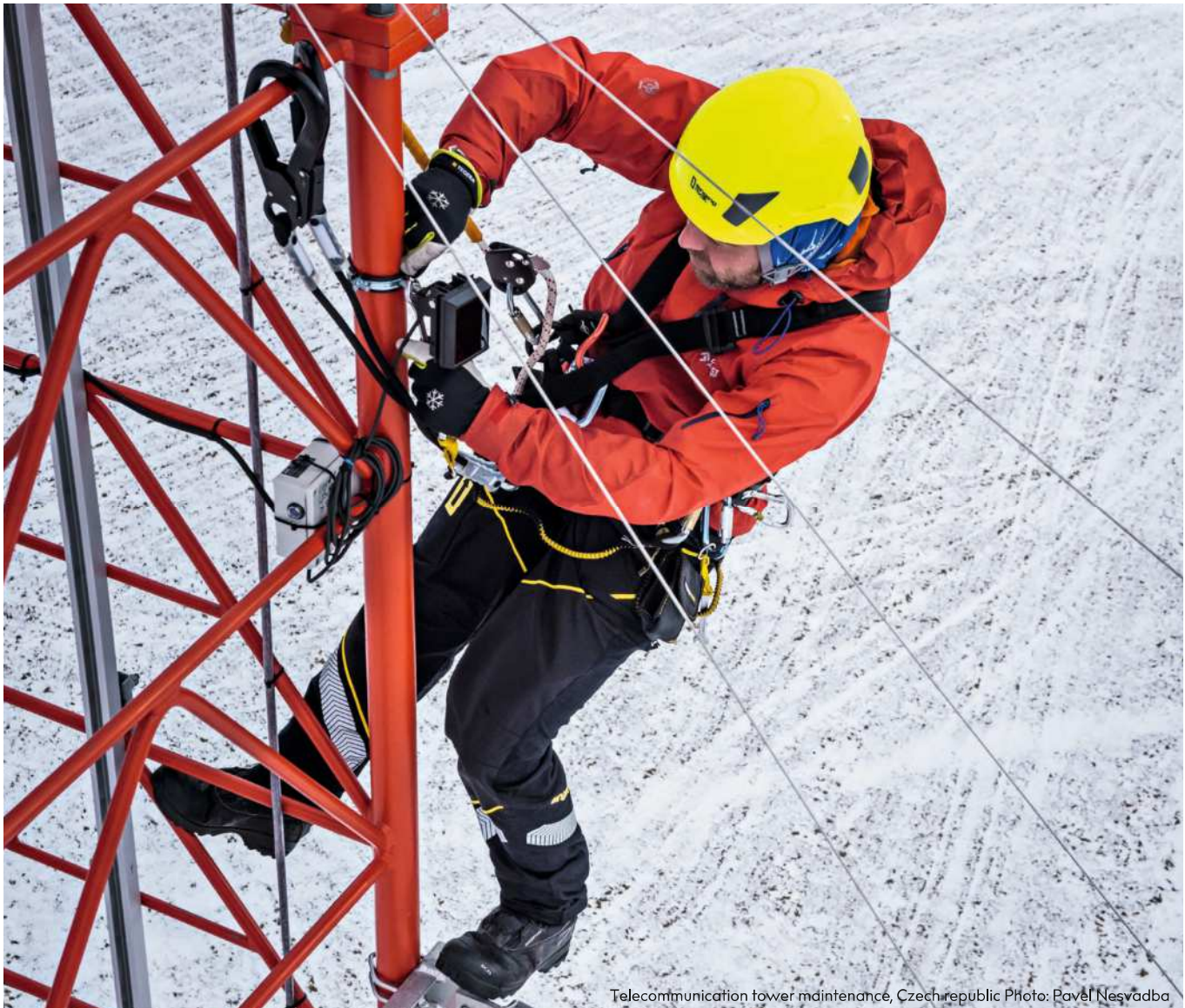

Telecommunication tower maintenance, Czech republic Photo: Pavel Nesvadba

IKAR HWS

 IKAR HWS 6 – A4000S060
 IKAR HWS 9 A4000S090

 IKAR HWS 12 – A4000S120
 IKAR HWS 24 – A4000S240

Self-retractable arrester featuring a rotating attachment swivel and a connector with fall indicator and double action swivel hook.

- lightweight aluminium housing with a galvanised steel cable lifeline
- swivel eye anchor attachment point
- additional testing against falls over edges ($r \geq 0,5\text{mm}$)
- steel double action hook on end of lifeline

Weight: 3 kg / 3.7 kg / 5.4 kg / 8.4 kg
 Length: 6 m / 9 m / 12 m / 24 m
 Working load: 136 kg

CE 0229, EN 360, ANSI/ASSE Z359.1-2007, ANSI/ASSE Z359.14-2014, CSAZ259.2.2

IKAR H

 IKAR H 33 – A4002BS33
 IKAR H 42 – A4002BS42

Self-retractable arrester featuring a connector with fall indicator and double action swivel hook.

- lightweight aluminium housing with a galvanised steel cable lifeline
- fixed handle anchor attachment point
- additional testing against falls over edges ($r \geq 0,5\text{mm}$)
- steel double action hook on end of lifeline

Weight: 18 kg / 27.2 kg
 Length: 33 m / 42 m
 Working load: 136 kg

CE 0229, EN 360, ANSI/ASSE Z359.1-2007, ANSI/ASSE Z359.14-2014, CSA Z259.2.2

IKAR HRA

 IKAR HRA 12 – A4004BS12
 IKAR HRA 18 – A4004BS18
 IKAR HRA 33 – A4004BS33

Self-retractable arrester with built in two-way rescue/ recovery mechanism. Fall arrest device with rescue lifting and lowering facility, equipped with a recovery mechanism operated by a device mounted handle. After an arrested fall, or if the user becomes incapacitated at the bottom of a shaft, the recovery mechanism can easily be engaged by a second person to raise or lower the person to a place of safety.

- lightweight aluminium housing with a galvanised steel cable lifeline
- fixed handle anchor attachment point

- equipped with a release pin and a recovery mechanism operated by a device mounted handle
- steel double action hook on end of lifeline

HRA is not suitable for use over a leading edge and has not been edge tested.

Weight: 11.5 kg / 21 kg • Length: 18 m / 33 m
 Working load: 136 kg

Weight: 7 kg / 11.5 kg / 21 kg
 Length: 12 m / 18 m / 33 m

CE 0229, EN 360, EN 1496, ANSI/ASSE Z359.1-2007, ANSI/ASSE Z359.14-2014, CSAZ259.2.2



DAVIT

Davit has a modular design that allows to build a system, which would precisely fit all possible applications in every confined environment. The swivelling davit sets are free standing or attachable to walls, tanks or other entrances. A simple plug-in mechanism allows quick and purposeful installation. In order to build your davit system, order a cantilever arm, choose from a range of fixed or temporary bases and sleeves and add required consoles for IKAR HRA self-retracting lanyards or PLW winch attachment. Designed with an integrated, easy to set fall brake system and the ability to mount mechanical devices as winches and retractable fall arresters, IKAR davits provide the customer with peace of mind for years to come.

IKAR AAS-1 CANTILEVER ARM

X4005XX00



Cantilever arm with permanent angle of 49° is developed for stationary use in safety and rescue cases for two persons, as well as for lifting and lowering loads.

- built-in 3 pulley systems redirect wire ropes from attachment point of the winch and SRL to confined space entry
- Cantilever arm is made from high quality V4A stainless steel
- Suitable for fast relocation from one sleeve to another due to foldable design of 2 detachable parts – upper davit and lower mast.

- Additional attachment point provides a possibility of attaching an SRL or fall absorber with lanyard to secure a cantilever arm operator or assistant.
- Suitable for two persons with load capacity of 300 kg

Height: 2,01 m • Reach: 0,74 m
 Weight: 28,7 kg
 € 0299 • EN 795:2012 Type B
 CEN/TS 16415:2013

IKAR GROUND SLEEVE

X4006XX00



Sleeve is designed to be installed onto the ground with pivot bearing made of durable PA.

Sleeve can be mounted on existing concrete surfaces using the recommended composite anchor system Type MKT VMZ-AA4 145 M16-30 / 200 or steel constructions with screw connections M 16 grade 8.8.

Material: stainless steel 1.4571 (V4A), PA
 Dimensions: 300 x 240 x 280 mm
 (length x width x height)
 Weight: 13,5 Kg
 EN 795:2012 Type A
 CEN/TS 16415:2013

IKAR WALL SLEEVE

X4007XX00



Sleeve is designed to be installed onto the wall with pivot bearing made of durable PA.

Sleeve can be mounted on existing concrete surfaces using the recommended composite anchor system Type MKT VMZ-AA4 145 M16-30 / 200 or steel constructions with screw connections M 16 grade 8.8.

Material: stainless steel 1.4571 (V4A), PA
 Dimensions: 290 x 300 x 410 mm
 (length x width x height)
 Weight: 14,9 Kg
 EN 795:2012 Type A • CEN/TS 16415:2013

IKAR LOWER GROUND SLEEVE

X4009XX00



Flush floor sleeve with 1 1/2" drainage pipe connection can be mounted to rebar before pouring concrete.

A concrete quality of at least B25 concrete must be ensured.

Material: stainless steel 1.4571 (V4A), PA
 Dimensions: 280 x 420 mm (width x height)
 Weight: 12 Kg
 EN 795:2012 Type A • CEN/TS 16415:2013

IKAR LOWER GROUND SLEEVE CORE HOLE

X4010XX00



Flush floor sleeve with 3/8" drainage pipe connection to be installed to existing concrete by core-drilling and resin fix.

A suitable shrink-free grout is PCI swelling mortar with the designation „Grout 100“.

Material: stainless steel 1.4571 (V4A), PA
 Dimensions: 160 x 335 mm (width x height)
 Weight: 4,6 Kg
 EN 795:2012 Type A • CEN/TS 16415:2013

FIXING MATERIAL FOR GROUND AND WALL SLEEVE

X4008XX00



Composite anchor system Type MKT
 VMZ-AA4 145 M16-30 / 200 for IKAR
 ground and wall sleeve.

IKAR MOBILE GROUND BASE

X4011XX00



Free standing base featuring quick and easy assembling on site.

The base consists of a central socket, height adjustable pairs or front and back legs secured with ball-lock pins. Cantilever arm rotates 360°.

Material: stainless steel 1.4571 (V4A), PA
 Dimensions: 1763 x 2228 x 450 mm
 (length x width x height)
 Weight: 23,4 Kg for central socket,
 front leg 8,1 kg each, back leg 9,2 kg each
 € 0299 • EN 795:2012 Type B • CEN/TS
 16415:2013

IKAR MOBILE ATTICS BASE

X4012XX00



Sleeve is designed to sit on the top of a concrete bund wall 200mm–400mm or container edges.

It is ideal for work areas where frequent assembly and disassembly is required.
Material: stainless steel 1.4571 (V4A)

Dimensions: 350 x 729 x 335 mm
(length x width x height)

Weight: 35 kg

CE 0299 • EN 795:2012

Type B • CEN/TS 16415:2013

IKAR WINCH CANTILEVER ARM CONSOLE

X4015XX00



Stainless steel bracket designed to fit IKAR PLW Winch to cantilever arm.

Bolts directly onto the davit's arm and comes complete with fixings and stainless-steel fixing pin for the PLW winch.

Material: aluminium

Dimensions: 200 x 130 x 82,5 mm
(length x width x height)

Weight: 2,4 kg

CANTILEVER ARM CONSOLE

IKAR HRA 12-24 – X4013XX00

IKAR HRA 33 – X4014XX00



Stainless steel bracket designed to fit IKAR HRA recovery devices to IKAR Davit's mast.

Bolts directly onto the davit' mast and comes complete with fixings and stainless-steel fixing pin for the device.

Material: stainless steel 1.4571 (V4A)

Dimensions: 264 x 162 x 250 mm
(length x width x height)

Weight: 3,5 kg (5 kg for HRA 33 version)

IKAR DB-A3 TRIPOD

X4002XX00



Portable tripod with adjustable locking legs and 3 intergated pulleys. Head construction allows a variety of leg angles and a safety-chain-free design. Ideal for economical compliance in many basic confined space, fall arrest applications and rescue.

- Up to 2,54 m high aluminium tripod with corrosion-resistant coating featuring 3 bolts-in anchor points
- 1,56 m in collapsed setup for transportation, weight is 24 kg
- 2 stage independently adjustable telescopic legs with stainless steel pins and foldable rubber shoes with spiked edges. The individually adjustable legs

are advantageous as they can be used on uneven ground

- 3 pulleys built into a die casted head
- Tripod is designed to be used without support safety chain, which reduces a risk of tripping
- Suitable for two persons with load capacity of 300 kg
- Console and IKAR HRA not included

Height: min. 1,43 m, max. 2,54 m

Diameter: min. 0,64 m, max. 2,19 m

Weight: 24 kg

CE 0299 • EN 795:2012-10 Typ B • CEN/TS 16415:2013

IKAR WINCH TRIPOD CONSOLE

X4004XX00



Aluminium bracket to connect an IKAR PLW Winch to IKAR DB-A3 tripod.

Dimensions: 200 x 130 x 82,5 mm

(length x width x height)

Weight: 2.0 Kg

IKAR HRA TRIPOD CONSOLE

X4003XX00



Universal aluminium bracket to connect an IKAR HRA (up to 60m) to an IKAR DB-A3 tripod.

Dimensions: 255 x 165 x 78 mm

(length x width x height)

Weight: 1.8 Kg



IKAR PLW WINCH

A4064XX30



Hand crank winch for easy and jerk-free lifting and lowering of persons and loads according to Directive 2006/42/EG with 30 m stainless steel rope of Ø 6mm (min. breaking load 18.76 kN). SWL is 300 Kg.

Material: stainless steel 1.4571 (V4A), PA
Dimensions: 230 x 336 x 200 mm (length x width x height)

Weight: 18,5 kg

CE • EN 1808:2015

EVAQ

W1510X000



Descender and rescue device for height rescue from places like cable cars, outdoor parks, wind power plants, cranes or skyscrapers. Simple operation offers an additional escape route for quick and efficient self-rescue of several persons using a shuttle system.

- designed for a working load of 150 kg (1 person)
- automatic and redundant brake system consists of 2 fly wheel brakes
- brake drums are made from steel for high resistance
- top 40 cm sling lanyard is equipped with a steel double trigger automatic locking connector with a gate opening of 21 mm for versatile and easy hanging (note: the connector is not shown on the pictures)
- HYPERLINK „<https://www.singingrock.com/eva-q-ropes>“ static polyamide kernmantle rope (acc. to EN 1891-A, \varnothing 9.6 mm) can be up to 300 m long
- both ends of the rope are equipped with a stitched eye and a steel double trigger automatic locking connector with a gate opening of 21 mm
- when the device is stored in a sealed pack by Singing Rock an inspection is required every 10 years only

- as an accessory, we also offer a HYPERLINK „<https://www.singingrock.com/protective-case>“ shock and waterproof plastic box in two sizes with a volume of 17 and 46 litres

Weight: 1.75 kg (3.9 lb) + rope
 Length: descent height max. 300 m (985 ft)
 Working load: 30 - 150 kg (66 - 330 lb) designed for 1 person
 Descending speed: approx. 0.8 m/s
 Temperature range: -40 °C to +65 °C
 CE 0511 • EN 341:2011-IB

EVAQ HUB

W1511X000



Descender and rescue device with lifting function for height rescue by fire fighters, industrial climbers and others when exposed to a danger at great heights such as cable cars, outdoor parks, wind power plants or skyscrapers. Also suitable for quick and easy rescue and even for self-rescue of many threatened people.

- designed for a working load of 225 kg (2 persons)
- automatic and redundant brake system consists of 2 fly wheel brakes
- brake drums are made from steel for high resistance
- equipped with a handwheel made of durable plastic for easy and save operation even in hard conditions and under a full load
- three stainless steel eyebolts ensure smooth descend speed control and multiple operation modes /back side rope clamp facilitates lifting operation
- to make the lifting easier the device is equipped with a hexagon adapter for accu-drill connection
- attachment point is equipped with a steel double trigger automatic locking

connector with a gate opening of 21 mm for versatile and easy hanging

- HYPERLINK „<https://www.singingrock.com/eva-q-ropes>“ static polyamide kernmantle rope (acc. to EN 1891-A, \varnothing 9.6 mm) can be up to 300 m long
- both ends of the rope are equipped with a stitched eye and a steel double trigger automatic locking connector with a gate opening of 21 mm
- when the device is stored in a sealed pack by Singing Rock an inspection is required every 10 years only
- as an accessory, we also offer a HYPERLINK „<https://www.singingrock.com/protective-case>“ shock and waterproof plastic box in two sizes with a volume of 17 and 46 litres

Weight: 3.4 kg (7.5 lb) + rope
 Length: descent height max. 300 m (985 ft)
 Working load: 30-225 kg (66-225/495 lb) designed for 2 persons
 Descending speed: approx. 0.8 m/s
 Temperature range: -40 °C to +65 °C
 CE 0511 • EN 1496:2007-B • EN 341:2011-1A

EVAQ ROPE

W1512X



Rope for the EvaQ a EvaQ HUB rescue devices.

- length according to the customer's request, max. 300 m
- both ends of the rope are equipped with a stitched eye and a steel double trigger automatic locking connector with a gate opening of 21 mm

Material: polyamide
Diameter: 9.6 mm

VACUUM PACKING

W1513XX00



Vacuum packaging the EVAQ devices for long-term storage.

- when the device is stored in a sealed pack by Singing Rock an inspection is required every 10 years only
- maximum sealed width of pack is 90 cm

EVAQ BAG

W9003RX45

NEW



Storage bag with a capacity of 30 litres

- ideal for long term storage of rescue equipment
- made of waterproof and washable material
- zippered transparent pocket on the side for documents/list of contents in A4 format
- adjustable shoulder strap
- fast opening/closing with a durable toggle

Weight: 1000 g (35.3 oz)
Material: PVC
Volume: 30 litres

PROTECTIVE CASE

17 litres – W9002XX17
46 litres – W9002XX46



Shock and water proof plastic box for your gear.

PROTECTIVE CASE 17 litres:

Outside dimensions

L x W x H: 40 x 30 x 22.3 cm

Inside dimensions

L x W x H: 34.3 x 22.3 x 20.5 cm

Lid + bottom depth: 3.9 + 16.6 cm

Weight: 1.74 kg

PROTECTIVE CASE 46 litres:

Outside dimensions

L x W x H: 60 x 40 x 27.8 cm

Inside dimensions

L x W x H: 51.8 x 31.8 x 25.9 cm

Lid + bottom depth: 4.8 + 21.1 cm

Weight: 3.44 kg

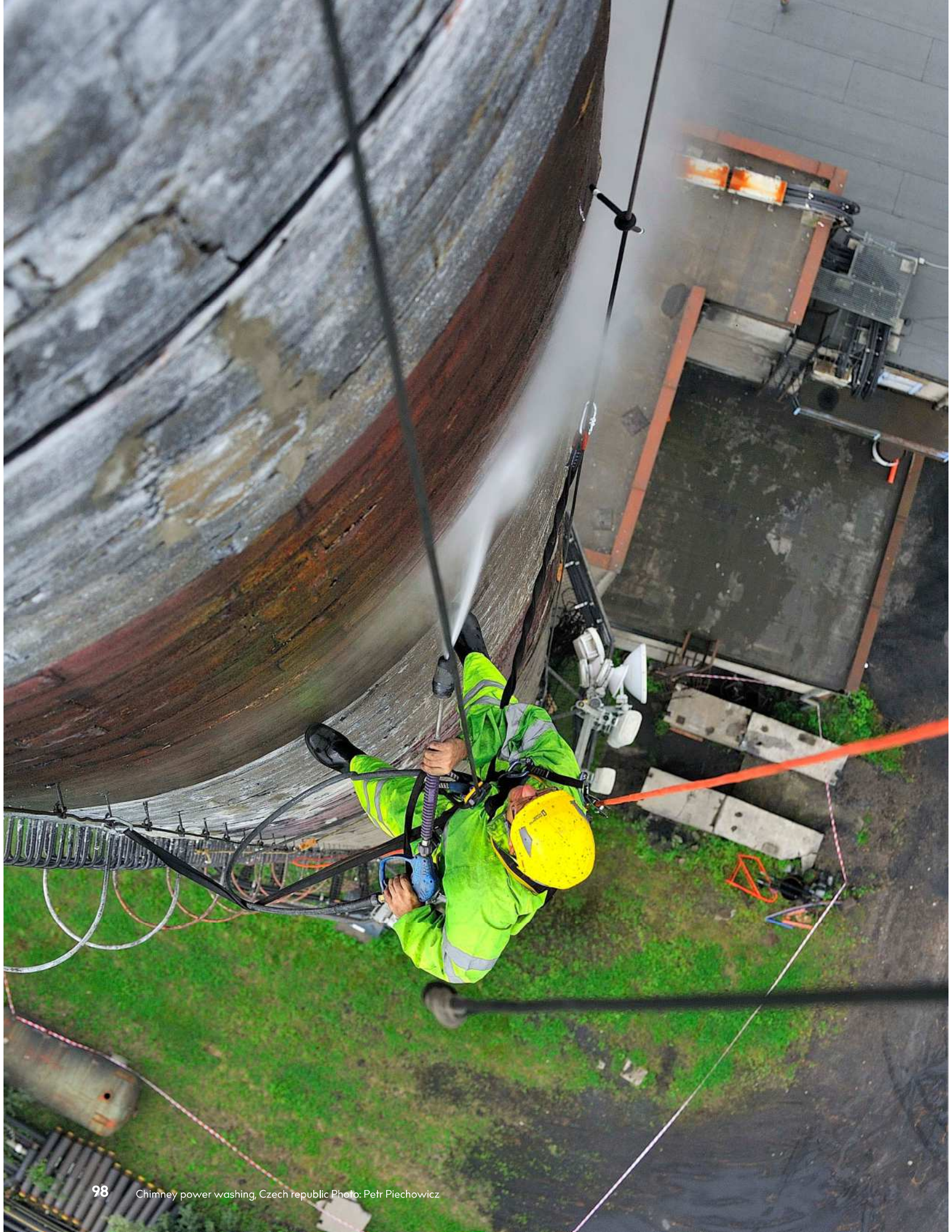

SLINGS AND LANYARDS

MOBILE ANCHORING SYSTEM
FALL ABSORBERS



OPEN SLING 22 KN



sewn sling, width: 19 mm

	[cm]	[in]	kN	type
W2001*060	60	24	22	
W2001*080	80	32	22	
W2001*120	120	47	22	
W2001*150	150	60	22	

CE 1019 • EN 566 • EN 795B • EN 354

EYE SLING 30 KN



sewn sling made of two layers of strength strap,
wear indication
width: 23 mm

	[cm]	[in]	kN	type
W2004*060	60	24	30	
W2004*080	80	32	30	
W2004*120	120	47	30	
W2004*150	150	60	30	

CE 1019 • EN 354 • EN 795B

SLING LANYARD 22 KN



sewn sling made of two layers of strength strap,
wear indication
width: 23 mm

	[cm]	[in]	kN	type
W2016*060	60	24	22	
W2016*080	80	32	22	
W2016*120	120	47	22	
W2016*150	150	60	22	

CE 1019 • EN 354 • EN 795B

LANYARD "I" 22 KN



lanyard • rope diameter: 10,5 mm

- available also with sewn connectors K370 or K353

	[cm]	[in]	kN	type
W2300W060	60	24	22	
W2300W080	80	32	22	
W2300W120	120	47	22	
W2300W150	150	60	22	
W2301*060	60	24	22	K3702PP
W2301*080	80	32	22	K3702PP
W2301*120	120	47	22	K3702PP
W2301*150	150	60	22	K3702PP
W2303*060	60	24	22	K3536PP00
W2303*080	80	32	22	K3536PP00
W2303*120	120	47	22	K3536PP00
W2303*150	150	60	22	K3536PP00

€ 1019 • EN 354 • EN 795B

LANYARD "V" 22 KN



lanyard

rope diameter: 10,5 mm

	[cm]	[in]	kN	type
W2200W001	25/45	10/17	22	
W2200W002	25/65	10/30	22	
W2200W100	100/100	40/40	22	

€ 1019 • EN 354

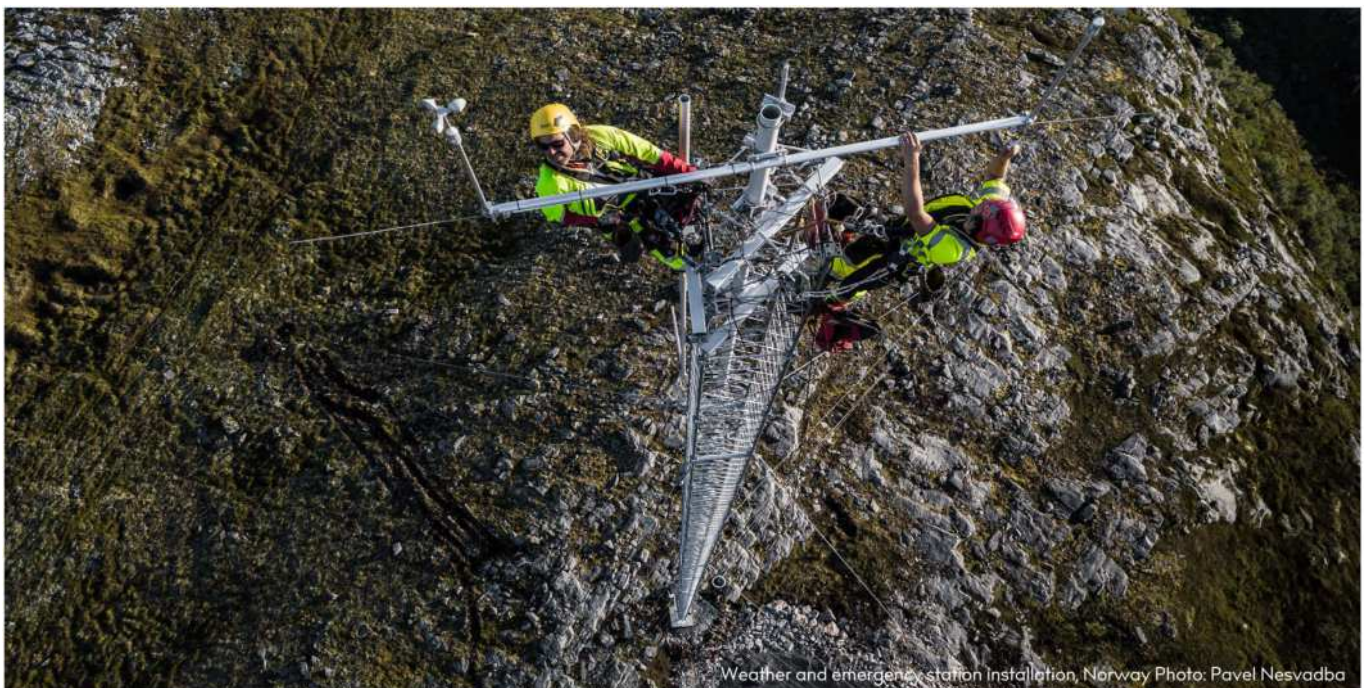

Weather and emergency station installation, Norway Photo: Pavel Nesvadba

LARA



Lanyard and anchor device for working in height made from dynamic rope. Its energy absorption capabilities significantly decrease impact force, however LARA IS NOT energy absorber.

LARA is tested according to EN 354 for lanyards and also according to EN 795B for the anchor devices. Both ends of the rope are terminated with stitched eyes for placing carabiners. Strength seam is protected with a plastic cover. Singing Rock recommends using carabiners with sling/rope fixation, which do not scroll in the loop and are all the time ready for use. LARA forms part of a fall arrest system and shall be used appropriately.

WARNING: LARA lanyard can not be used as a fall absorber!

lengths: 60, 80, 120, 150 cm
 € 1019 • EN 354 • EN 795 Type B

	[cm]	[in]	kN	type
W2100X060	60	24	22	
W2100X080	80	32	22	
W2100X120	120	47	22	
W2100X150	150	60	22	

TRACK PLUS

W1036W130



Adjustable anchoring strap and work positioning lanyard

- length adjustment from 80 to 130 cm
- € 1019 • EN 354 • EN 358 • EN 795 B

ADJUST

W1047Y100

NEW



Adjustable lanyard with steel single buckle and textile handle which allows adjusting a length under the tension.

- strong and resistant 25 mm wide webbing, eye with a protector for any EN 362 connector, big steel buckle for adjusting a length of the lanyard
- full strength textile handle for easy adjusting a length of the lanyard (guaranteed safety of this loop in case of wrong attachment)

- attachment light alloy ring with the inner diameter of 28 mm
- identification label for product traceability

Weight: 240 g • 8.5 oz
 Material: PES • Strength: 22 kN
 Width: 25 mm • 1 in
 Length: 80–145 cm • 32–57 in
 € 1019 • EN 354 • EN 358 • EN 795 B

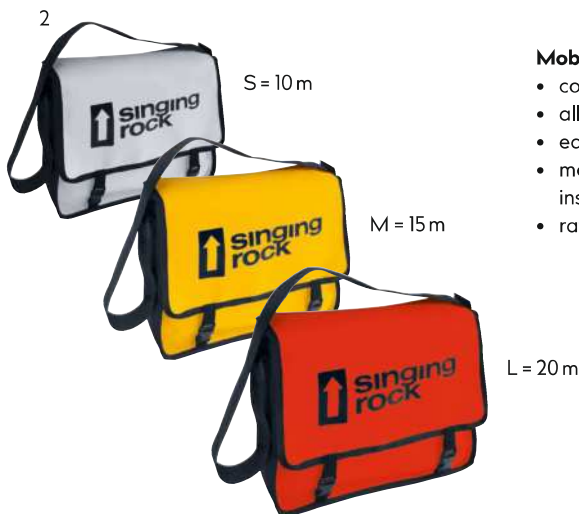
FINE LINE

MOBILE ANCHORING SYSTEM

Mobile anchoring system

- colour distinction of the lengths
- allows 2 persons movement
- easy to adjust and manipulate
- manpower sufficient for fastening when installing the system
- ratchet does not damage the webbing

W1001WW10	Fine line 10 (1)
W1001WW15	Fine line 15 (1)
W1001WW20	Fine line 20 (1)
W1002WS10	Fine line bag 10 (2)
W1002WY15	Fine line bag 15 (2)
W1002WO20	Fine line bag 20 (2)

€ 1019 • EN 795 B



STEEL ANCHOR 300 cm – RK851XX03
500 cm – RK851XX05**Steel anchoring device ideal for tree care or welding at height.**

- Steel wire cable with the diameter 6 mm is protected by thick PVC tube. Outer diameter of the tube is 13 mm.
- available in two lengths with different loop colors

Material: zinc plated steel covered by PVC
 Strength: 15 kN
 Length: 300, 500 cm • 9.8 ft, 16.4 ft
 Weight: 730 g • 25.8 oz
 1150 g • 40.6 oz
 CE 1019 • EN 795B

STEEL LANYARD "I" yellow – RK850X100
blue – RK850X130
red – RK850X180**Steel connecting and anchoring device ideal for tree care or welding at height.**

- Steel wire cable with the diameter 6 mm is protected by thick PVC tube. Outer diameter of the tube is 13 mm.
- both ends finished with a fixed eye
- combination of very good strength and durability
- available in three lengths with three different loop colors
- unique production number

Material: zinc plated steel covered by PVC
 Strength: 15 kN
 Length: 100, 130 and 180 cm • 39, 51 and 71 in
 Weight: 295 g • 10.4 oz • 350 g • 12.3 oz • 460 g • 16.2 oz
 CE 1019 • EN 354 • EN 795B

AXILLAR

W0003BY09

**Rescue sling to secure evacuated persons against accidental fall during the rescue action**

(e.g. ski lift evacuation).
 Weight: 355 g
 EN 1498 type A

JACOB DYNEEMA

C2151BY00



Versatile and ultra light ladder.

- used for aid climbing and work at height
- any cell may be loaded in any directions, which can become useful in emergency situations
- strength of each loop – 22 kN
- may be also used as an open sling for the anchoring

Length: 140 cm (55 in)
Weight: 140 g • 4.9 oz
CE 1019, EN 566, EN 354

JACOB

C2150BY



Ultra light six step ladder.

Steps reinforced with a plastic to hold its shape even under the load.

Maximum load: 500 kg.
Maximum load for grab loop 100 kg.
Length: 150 cm (59 in)
Weight: 210 g • 7.4 oz

FOOTER II

W1024BX
complete – W1025BX



Ascender webbing for rope access.

- big loop for easy releasing the webbing
- small loop for the attachment to the carabiner
- reinforced step loop
- FOOTER II COMPLETE is including the maillon connector

Min. length: 40 cm (16 in)
Max. length: 140 cm (55 in)
Weight: 90 g • 3.2 oz / 125 g • 4.4 oz (complete)
Max. load: 150 kg

FOOTER XP

W1051BX

NEW

Lightweight ascender loop made from 6 mm accessory cord.

- webbing in the buckle simplifies the length adjustment
- XP buckle allows to adjust the length even when loaded
- big hole in the buckle for the attachment with any type of carabiner
- reinforced step loop is equipped with an elastic strap which keeps the proper position of the foot

Min. length: 30 cm (12 in)
 Max. length: 170 cm (67 in)
 Weight: 105 g (3.7 oz)
 Max. load: 180 kg
 Material: PAD, light alloy

TOOL HOLDER

W1028BY00



Elastic sling to attach the tools to the harness which makes the loss of the tool impossible.

- designed to provide comfortable work while working with the tools at height
- high durability and flexibility
- steel weldet eye
- length of the sling can be extended up to 130 cm

Material: PES, PAD, steel, elastic fibre
 Load capacity: 3 kg
 Weight: 30 g • 1.06 oz
 Length: 70 cm, (130 cm fully extended)

Never use this sling for belaying!

FLAT WEBBING

C0035AO12



- width of webbing 16 mm (0.63 in)
- made of low stretch PES
- max. length 120 m (393 ft)
- weight: 37,7 g/m
- strength: 15 kN

CE 1019 • EN 565

TUBULAR WEBBING

black – C0037BB12
 red – C0037RR12



- width of webbing 20 mm (0.79 in)
- made of low stretch PES
- max. length 120 m (393 ft)
- weight: 38,2 g/m (black), 39,4 g/m (red)
- strength: 16 kN (black), 17 kN (red)

CE 1019 • EN 565

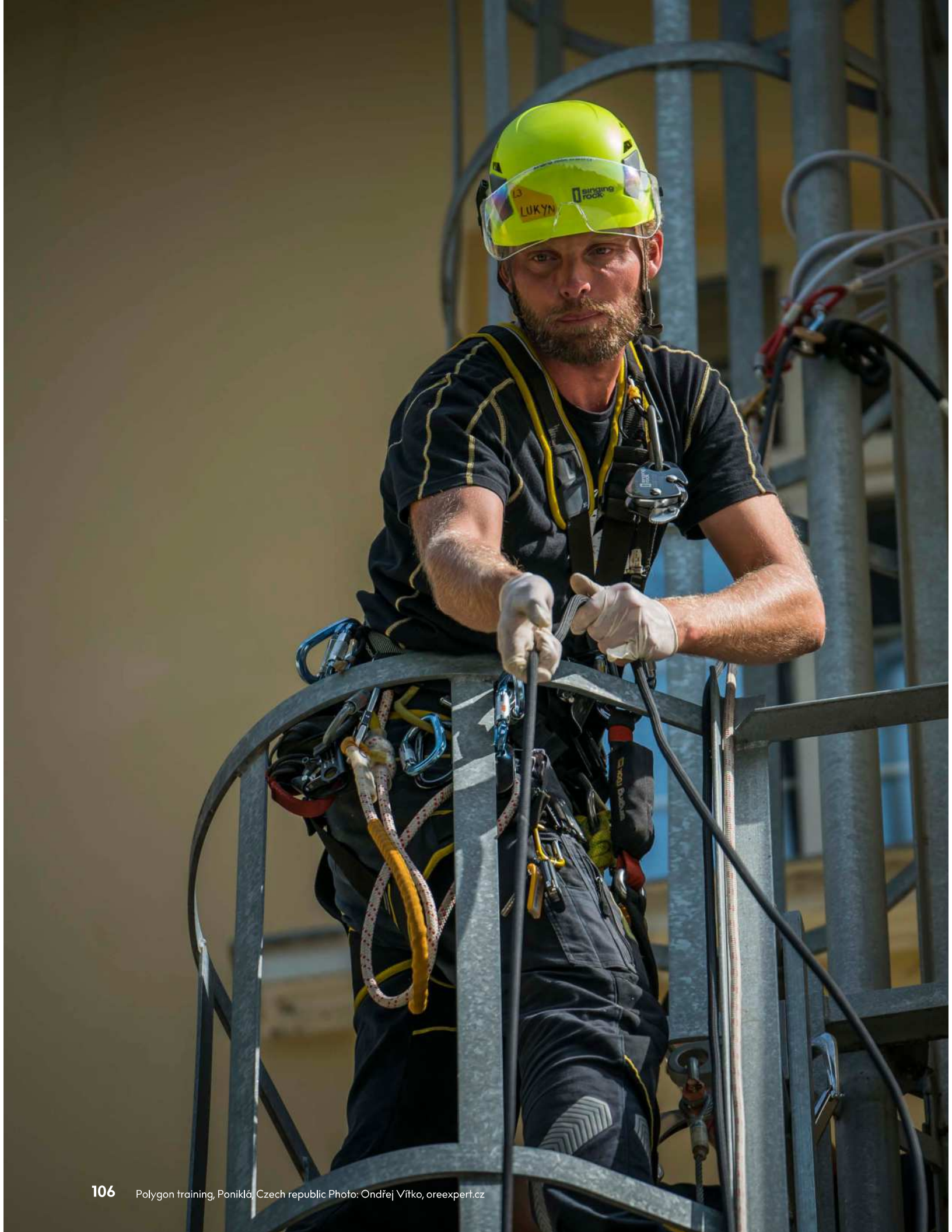

REACTOR 140

W4400WW00



Shock absorber used primarily by workers on a structures, ladders and pylons. Lightweight, practical shape does not restrict users at the work. Newly designed for users with a maximum weight of 140 kg (including equipment).









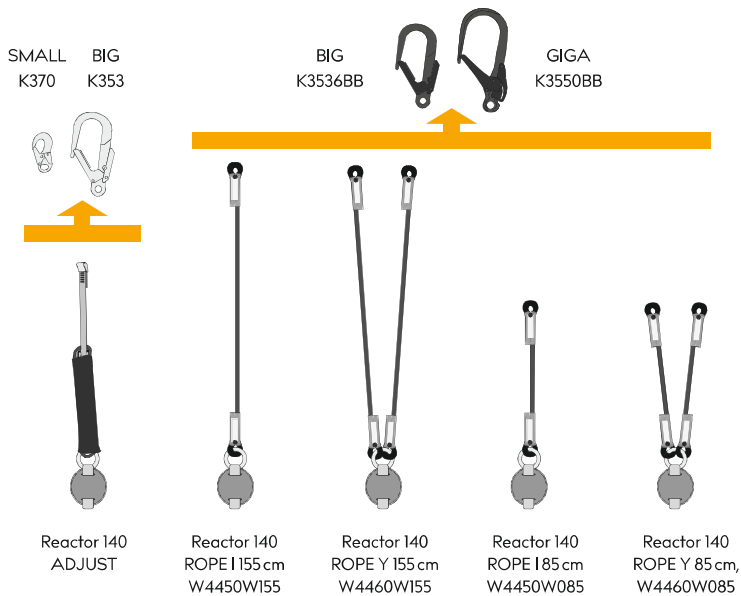
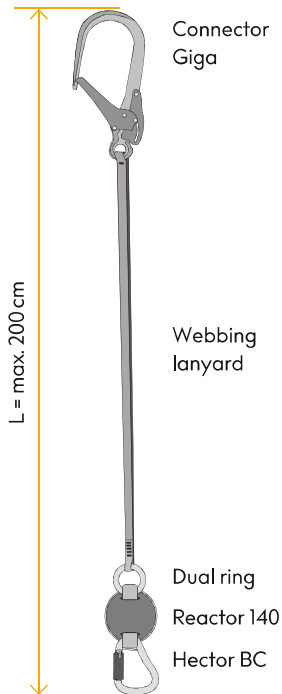

- designed to safely capture a person weighing 140 kg (including equipment)
- maximum active breaking length of shock absorber is 175 cm
- optional length of lanyards for diverse work
- zipper around the perimeter of the cover for easy inspection of the energy absorber
- intact, orange indicator of energy absorber activation

- any EN 362 certified connector can be sewn into the attachment loop
- orange indicator is threaded through the attaching loops and indicates an actual damage
- cover is made from black synthetic rubber and Cordura with PU coating
- oval shape for easy grip
- different webbing lengths are produced on customer's request

Weight: 170 g • 6 oz (without any connector and lanyards)
 WLL: 140 kg
 € 1019 • EN 355

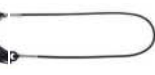
Lanyards and connectors:



Type	Code	Connectors	Length of system [cm]	Weight [g]	
 „I“ 85 cm	1	W4410W085	–	85	250
	2	W4411W085	K370	100	400
	3	W4412W085	K353	110	750
	4	W4413W085	K355	120	1230
 „I“ 155 cm	5	W4410W155	–	155	290
	6	W4411W155	K370	170	440
	7	W4412W155	K353	180	830
	8	W4413W155	K355	190	1270
 „Y“ 85 cm	9	W4420W085	–	85	210
	10	W4421W085	2x K370	100	610
	11	W4422W085	2x K353	110	1290
	12	W4423W085	2x K355	120	2210
 „Y“ 155 cm	13	W4420W155	–	155	390
	14	W4421W155	2x K370	170	690
	15	W4422W155	2x K353	180	1390
	16	W4423W155	2x K355	190	2310
 EYE „Y“ 155 cm	17	W4430W155	–	155	390
	18	W4433W155	2x K355	190	2310
 RING „Y“ 155 cm	19	W4440W155	–	155	530
	20	W4441W155	2x K370	170	830
	21	W4442W155	2x K353	180	1510
 ADJUST	22	W4470Y100	–	100–160	420
	23	W4471Y100	K370	115–175	570
	24	W4472Y100	K355	125–185	920
 ROPE „I“ 85 cm	25	W4450X085	–	85	290
	25	W4452X085	K353	110	790
	26	W4453X085	K353	120	1260
 ROPE „I“ 155 cm	27	W4450X155	–	155	370
	28	W4452X155	K353	180	870
	29	W4453X155	K355	190	1340
 ROPE „Y“ 85 cm	30	W4460X085	–	85	400
	31	W4462X085	2x K353	110	1400
	32	W4463X085	2x K355	120	2340
 ROPE „Y“ 155 cm	33	W4460X155	–	155	520
	34	W4462X155	2x K353	180	1520
	35	W4463X155	2x K355	190	2460

JOULE

70 cm – W4100Y070
 120 cm – W4100Y120
 160 cm – W4100Y160



Fall absorber

The fall absorber Joule presents optimal solution for securing persons working on horizontal constructions and roofs. Joule is activated after reaching the load of 2 kN (200 kg). Minimal guaranteed strength after the breaking action is 15 kN.

CE 1019 • EN 355

JOULE 70 is possible to use with the fall absorber LOCKER, for working situation which requires longer distance from the safety line.

EN 353-2, EN 355

This is not a final product, this set is necessary to set up from the separate parts.

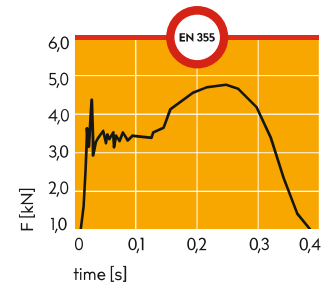

GrimpDay competition, Belgium, Photo: Michal Šafius

ROOFER SET

ROOFER SET 10 – M0020X1
ROOFER SET 20 – M0020X2

Roof set is ideal for those, who are fully devoted to roofing. It allows you to position yourself on a roof with up to 45° angle to prevent a possible fall due to slippage or breaking of a structure.

Set contains:

W0075DR

Sit worker 3D standard

W1011WB20

SITE – Locker+Static 11mm, (ROFER SET 10 – 10m,

ROFER SET 20 – 20m)

W2016X120

Sling lanyard 120, 22 kN (double safety sling)

K0018AA00

Carabiner OZONE Triple Lock

K4241ZO07

STEEL OVAL carabiner, Triple Lock

S9000YY35

GEAR BAG 35L YELLOW

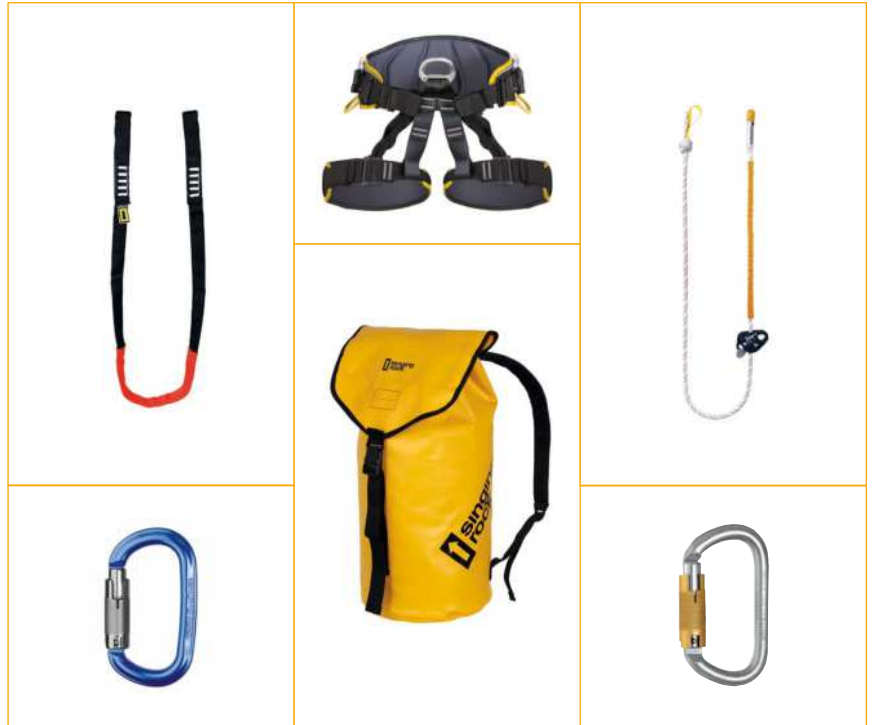

FALL ARRESTER SET

M0022XX

Set intended for work restraint situations or attaching to anchor lines. Versatile and lightweight set contains:

Set contains:

W0089SY

BASIC HARNESS

W4100Y160

JOULE 160

Fall absorber

K4241ZO05

STEEL OVAL

CARABINER, SCREW

GATE 2x

W0052B010

WORKING BAG 10L

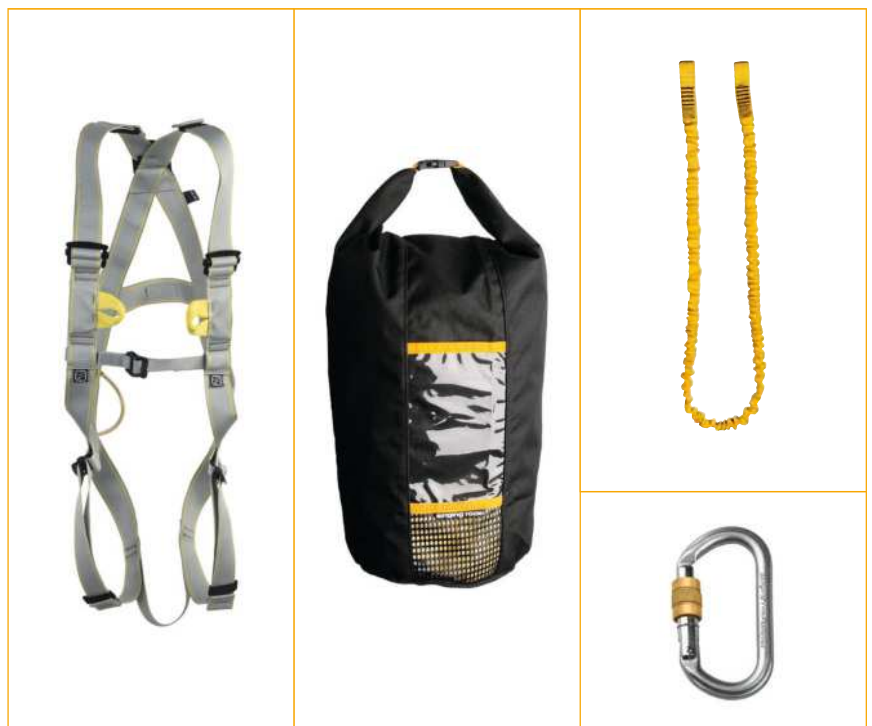

SCAFOLDER SET

M0021XX

Scaffolder set is intended for those, who install scaffolds or work on tall structures and towers. It allows you to reach safely a place of work and position there for work.

Set contains:

W0063BB	Technic harness
W4442W155	Reactor 140 RING „Y“ 155 cm + 2xK353
W1012WB02	SITE 2M + K370
K0018AA00	CAR. OZONE Triple Lock
K4241ZO07	STEEL OVAL CARABINER, TRIPLELOCK
W1023YY00	MONTY BAG YELLOW

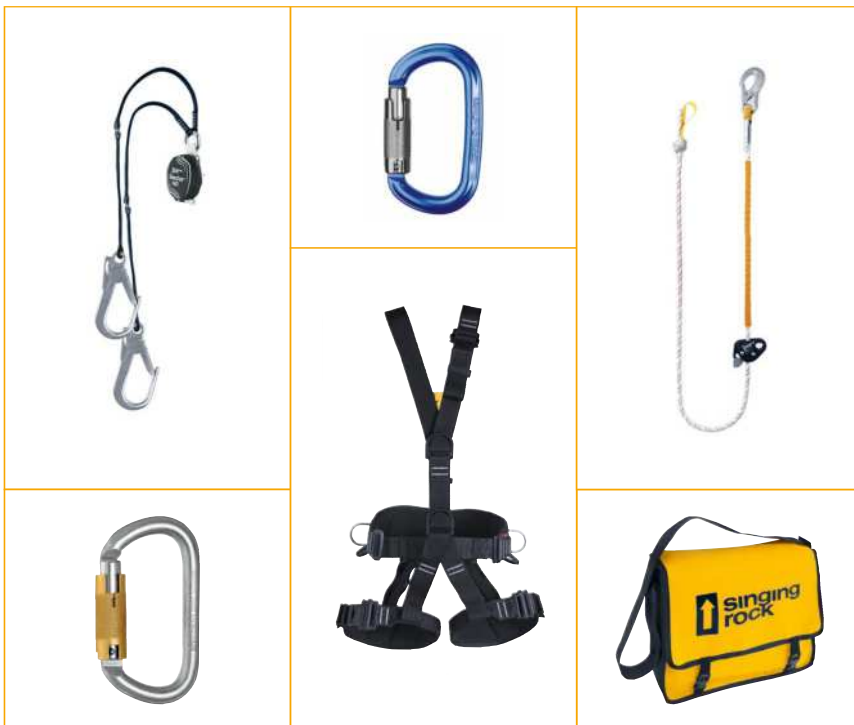

PPE INSPECTION SET

equipment for checking of PPE

M000XSET

X1023	Monty bag
X0013XX02	Wire (diameter 2 mm)
X0015XX00	Marker of textile PPE
X0016XX00	Gas Hot Knife
X0017XX00	Sliding Gauge
X0018XX00	Measuring Tape
X0019X400	Silicon Based Lubricant
X0020XX00	Illuminated magnifier
X0004GB00	Thermocutter
L9991WB	Periodic control labels + plastic films (price per package)
E0014XX00	File

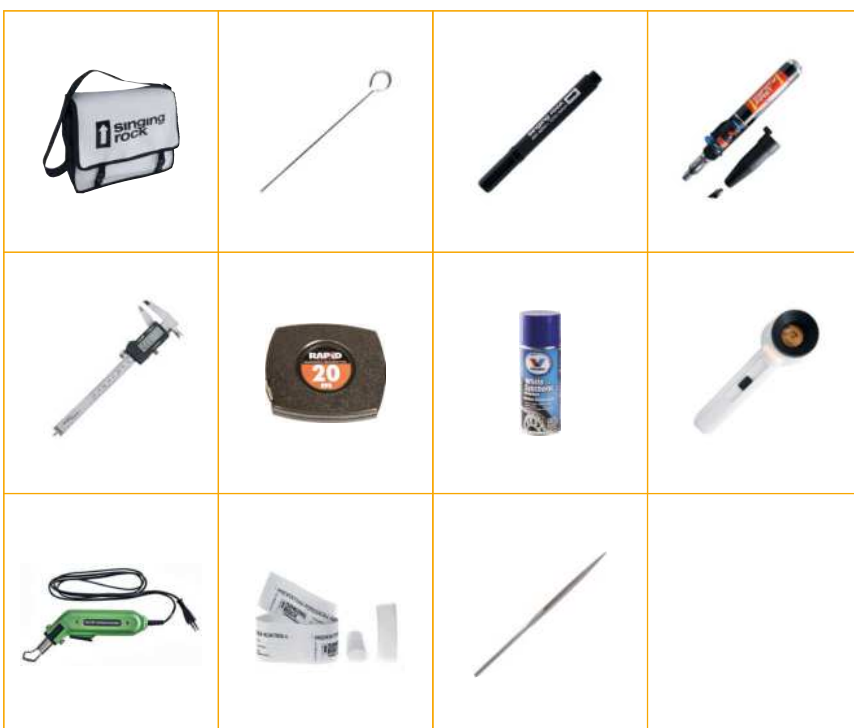

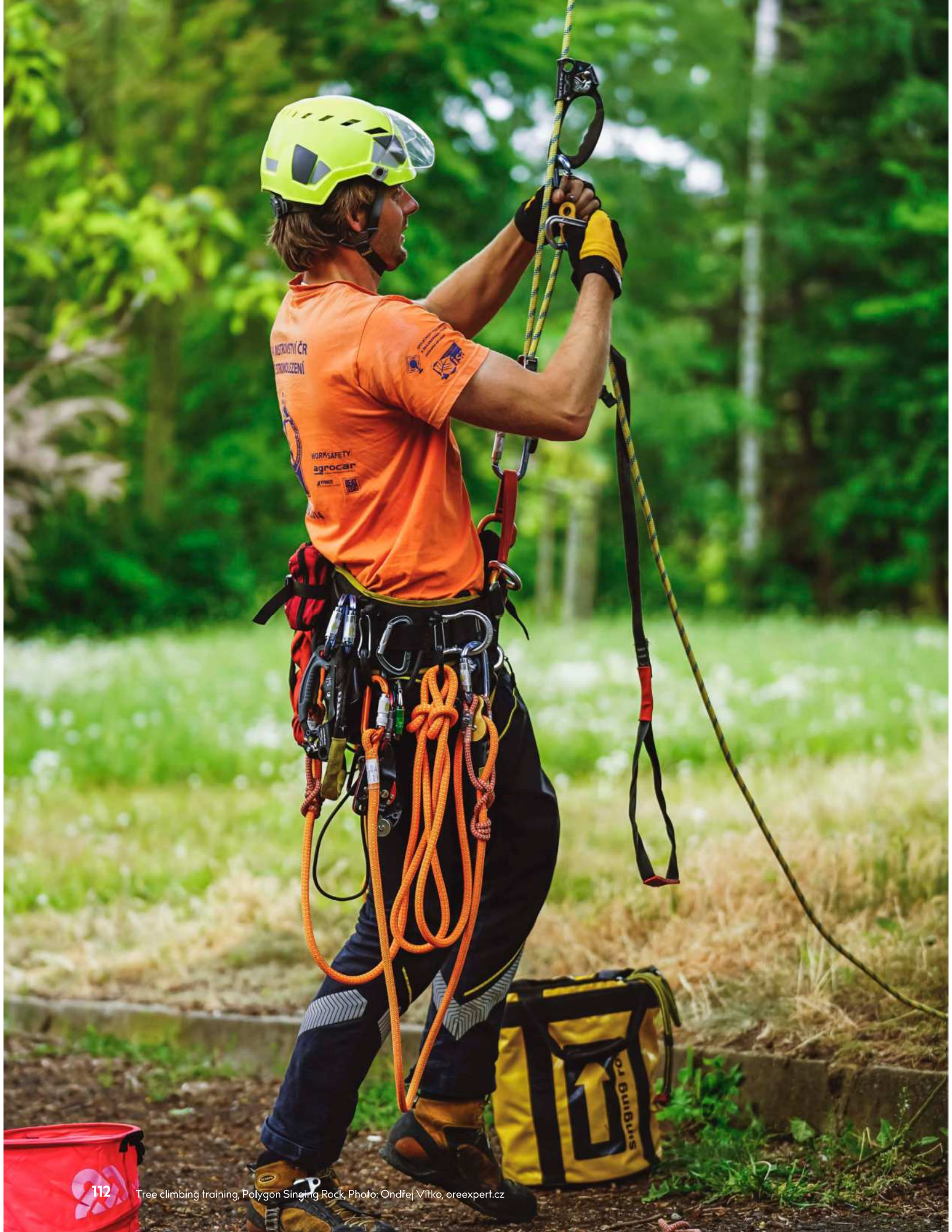

ACCESSORIES AND PROMOTIONAL



GEAR BAG

GEAR BAG 35 l black – S9000BB35
 GEAR BAG 35 l yellow – S9000YY35
 GEAR BAG 35 l red – S9000RR35

GEAR BAG 50 l black – S9000BB50
 GEAR BAG 50 l yellow – S9000YY50
 GEAR BAG 50 l red – S9000RR50



Transport bag for your gear

- waterproof, durable and washable
- very convenient to carry your gear
- takes up little space and stays dry
- transparent pocket (A4) on the top flap for your documents
- intended for speleology and working at heights
- minimum amount of seams
- main seams feature HF welding

Colors: yellow, red and black

Capacity: 35 and 50 litres

Material: PVC

Weight: 700 g • 24.7 oz – 35 l version

TARP DUFFLE

70 litres – C0046BB70

90 litres – C0046BB90

120 litres – C0046B120



Tarp duffel 120 l

Tarp duffel 70,90 l

Expedition bag 70, 90, 120 l

It's not your average duffel bag... Made from a durable laminate material, the TARP DUFFLE is an almost indestructible bag. Resilient enough to be roughed up in-flight, or to be transported up a mountain via a yak or off-road vehicle, this is one burly duffel bag. For longer trips, grab the 120 litres size so you have enough room for all your gear

- Alpine-cut shoulder straps
- Dual daisy chains
- Twin haul handles on ends
- Rugged construction with extra bartacks and double stitching
- Four compression straps

- Internal mesh pockets
- Pocket on top

Capacity: 70 l, 90 l, 120 l

Color: black

Max. load: 20 kg, 23 kg, 23 kg

Weight: 1820 g (70 l), 2270 g (90 l), 2720 g (120 l)

Material: PVC

MOVEMENT BAG

C0073BY00



Resistant traveling bag with the wheels for your climbing adventures, business trips or work at height missions.

- large u-shaped opening with heavy duty double zippers provides easy access to contents. Zippers can be easily locked with a padlock
- convenient side pocket allows you to keep e.g. footwear separate from clothing
- durable webbing straps and grab handle with reinforced stitching
- smooth rolling with all-terrain wheels for effortless mobility
- durable internally constructed push button locking handle adjusts to multiple heights for comfort whether gliding or pulling the bag

- side organization pocket for all of your travel needs
- heavy-duty PVC fabric backing
- rubberized, textured corner protectors guard against wear and tear at critical contact points
- plastic piping reinforce high friction zones
- one internal accessory pocket provide easy packing organization

Dimension: 77 x 39 x 38 cm

• 30.3 x 15.4 x 15.0 in

Capacity: 110 litres

Max. load: 23 kg

Weight: 4600 g (10.1 lb)

CARRY BAG

C0001YY00

**Practical bag intended for storage and transport of ropes as well as other gear.**

- made from durable and washable material
- plastic reinforcements keep the bag self-standing
- due to its shape it is easy to store the rope and rigging tools properly
- very convenient to carry your gear
- reinforced ergonomic plastic handle to haul the bag
- loop on the bottom to shake out the gear and dirt
- water resistant
- side pocket for the accessories
- 2 steel rings for shoulder strap to carry the bag easily
- fast closing system

Color: yellow / black
 Dimension: 30x40(58) cm
 Max. load: 28 kg
 Capacity: 28 + 10 l
 Material: PVC
 Weight: 940 g • 33.16 oz

DRY BAG

S9001YX40 - 40 l
S9001BX60 - 60 l**NEW****Dry bag with detachable shoulder straps intended for complete waterproof protection of your gear.**

- classic rolling system with an additional guide bar
- retaining rings against unwanted opening of the closure buckle
- washable extra-durable PLASTEL® fabric, UV and waterproof resistant
- metal D-ring for safety attachment
- easily detachable foam padded shoulder straps
- color differentiation of the bag volume

Color: yellow [40 l], black [60 l]
 Weight: 750 g • 26.5 oz (± 15 g • 0.5 oz) [40 l]
 Material: PVC, PE
 Volume: 40 or 60 litres

MONTY BAG

W1023

**Bag for your gear and documents**

- adjustable shoulder strap
- made of high resistant and durable fabric POLYMAR
- washable
- durable material
- colors: grey, yellow, orange, red

URNA

W1026BB



Leg rope bag

- for rappelling in the extreme conditions to have the rope under the control
- can be also used as a tool bag when working at the height
- easy to put on the user's leg and the harnesses with the plastic buckle
- made from high quality material
- max. length of the rope 50m of the diameter 11,5mm
- inside loop to tie the end of the rope
- easy closing system allows to feed the rope slowly

- the bag can be completely closed to avoid loosing the tools
- side pocket for small items or for the notebook

Color: black

Capacity: 11 litres

Weight: 240 g • 8.5 oz

ROPE BAG

C0001BB



With removable sheet.

- sheet dimensions 137 x 137 cm
- hidden pocket for keys and money
- well-padded shoulder straps
- abrasion resistant material

Weight: 620 g • 21.87 oz

WORKING BAG

 W0052B010
 XL – W0052B012

Transport bag for working harnesses – also suitable as a gear bag for tools

- made from high abrasion resistant material PES 600 g/m²
- simple closing system with a plastic buckle
- net on the bottom for better airflow (the bag is not waterproof)
- transparent pocket for the name tag or instruction of use
- wide opening for easier putting in the harness or gear

- inside stitching covered by lace webbing
- suitable for 30m rope (10.0 mm)

Color: black

Weight: 125 g / 130 g • 4.4 oz / 4.6 oz

Material: PES

Capacity 10 / 12 litres

TOOL BAG

W0008BS



Hardware carrier and organizer

- made of high resistant and durable fabric POLYMAR
- inside and outside pockets for hardware
- intended to be attached directly to the harness via carabiner or using additional waist belt
- well arranged
- easy to maintain
- maximum load – 10 kg
- dimension – 23 x 23 x 9 cm

Carabiner is not included.

POUCH

C0072BB00

**General purpose pouch.**

- closing with strong Velcro
- secure attachment loop to attach it to the belt or a harness
- strong abrasion resistant nylon fabric

Dimension: 10 x 6 x 11 cm
(4 x 2.4 x 4 in)

Weight: 42 g • 1.48 oz

FIRST AID BAG – LARGE

C0058RR00



(without the content)

- ideal for all of those who wish to choose -their own content
- bright colour increases the visibility in a bad weather or inside the backpack
- big attachment loop
- insert compartments in different sizes
- zipped big mesh pocket
- inside buckle with the emergency whistle
- high-durable material for the use in demanding conditions.

Dimension: 22 x 18 x 5 cm
material: polyamid, polyester
weight: 189 g • 6.7 oz



FIRST AID BAG

C0053RW



(without contents)

Compact and light first aid bag for minimalists

- ideal for all of those who wish to choose their own contents.
- all-round zip fastener with reflective component guarantees a good overview and easy access.
- two attachment loops;
- insert compartment in different sizes; zipped mesh pocket
- velcro attachment loop on the harness or a hip strap of backpack
- easily removable from the harness by one hand
- emergency whistle included

Dimension: 13 x 10 x 5 cm
material: polyamid, polyester
Weight: 61 g • 2.14 oz



RESCUE POLE

W8000BX00



Retractable Pole for attaching an anchor remotely

- Remote rescues
- Pole has a 2.5 m reach
- Slim fit shoulder bag with an additional pocket for heads storage
- Available with four different heads for connectors

Weight: 390 g • 13.8 oz
 Length Extended: 250 cm
 Length Retracted: 71 cm
 Diameter: 2.8 cm
 Material: fibre glass, brass bush, PVC rubber, stainless steel heads attachment

Head for connectors:

- W0024XX01 – for BORA/HECTOR
- W0024XX02 – for BIG CONNECTOR
- W0024XX03 – for GIGA CONNECTOR
- W0024XX04 - for SMALL CONNECTOR



W0024XX01



W0024XX02



W0024XX03



W0024XX04



Ski lift rescue, Paseky nad Jizerou, Czech republic Photo: Ondřej Vítko, www.oreexpert.cz

FALCONER FULL

C0012YB



Lightweight gloves featuring great grip, dexterity and ability.

- durable double layer of artificial and split cow grade A leather on the palm
- additional reinforcement of the high-wear area between forefinger and thumb,
- breathable abrasion resistant nylon on the back
- neoprene cuff with a reinforced attachment hole

Size: 8, 9, 10, 11
EN 420, EN 388

FALCONER TACTICAL

C0013YB



Lightweight gloves with uncovered tops of thumb, forefinger and middle finger making manipulation of metalwork simpler.

- durable double layer of artificial and split cow grade A leather on the palm
- additional reinforcement of the high-wear area between forefinger and thumb
- breathable abrasion resistant nylon on the back
- neoprene cuff with a reinforced attachment hole.

Size: 8, 9, 10, 11
EN 420, EN 388

FALCONER 3/4

C0014YB



Lightweight gloves with removed tops of fingers making manipulation of metalwork simpler.

- durable double layer of artificial and split cow grade A leather on the palm
- additional reinforcement of the high-wear area between thumb and index finger
- breathable abrasion resistant nylon on the back
- neoprene cuff with a reinforced attachment hole
- two special pull-off half-loops on top of middle and ring fingers to secure an easy put off.

Size: 8, 9, 10, 11
EN 420, EN 388

GRIPPY

C0006BH



Made out of quality leather. Reinforced palm area. Closed fingers. Abrasion resistant.

Gloves are easy to put on thanks to special pull-on loop.

Kevlar thread • Size: 8, 9, 10, 11
EN 388, EN 420

GRIPPY 3/4

C0006HH



Made out of quality leather. Reinforced palm area and lower part of finger area.

Exposed fingertips allow you to keep your sense of touch and manipulate your gear. Gloves are easy to put on thanks to a special pull-on loop.

Kevlar thread • Size: 8, 9, 10, 11
EN 388, EN 420

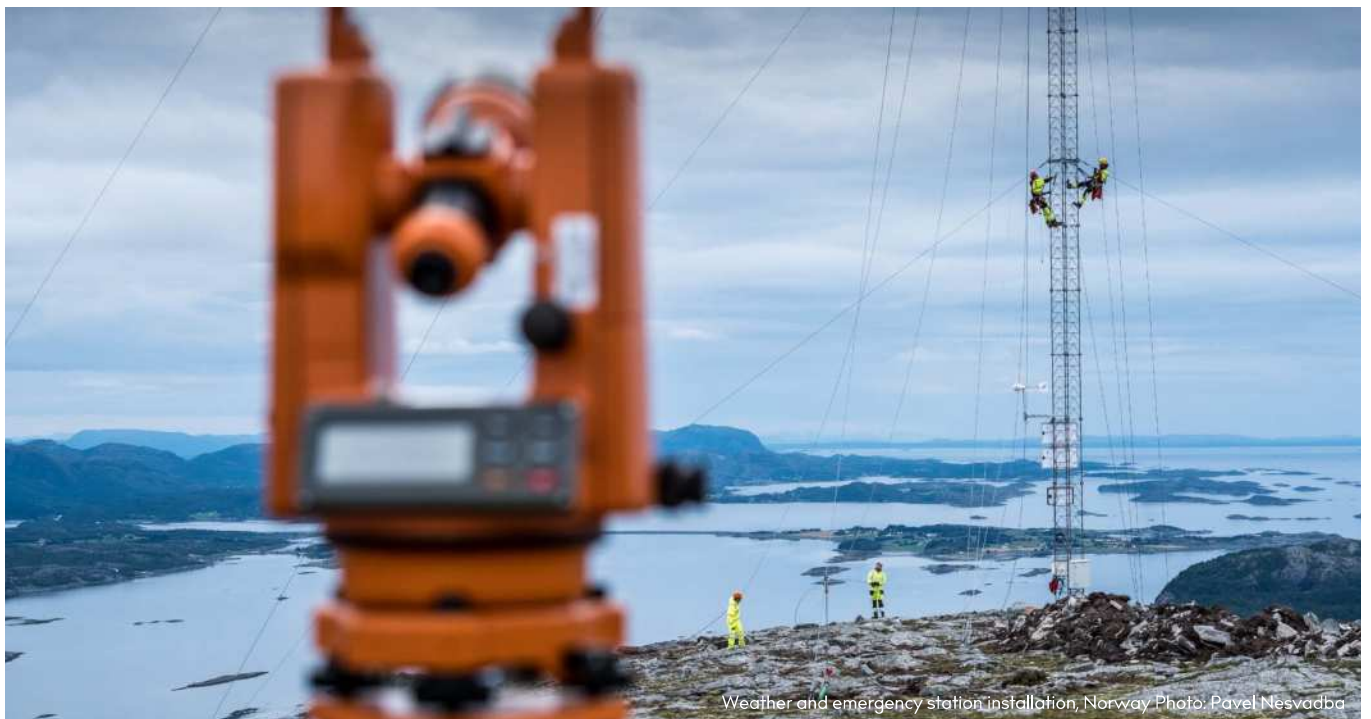

Weather and emergency station installation, Norway. Photo: Pavel Nesvadba

WORK KNIFE

A0031BS

**Pocket knife with first class stainless steel blade.**

- blade length 80 mm
- one hand operation and safety lock of opened knife
- stainless steel flexible clip for belt fixation, hole for the accessory cord fixation

Material:
blade and clip – stainless steel, plastic handle
Weight: 83 g • 2.9 oz

RESCUE KNIFE

A0030Y

**Special rescue knife with first class stainless steel ejection blade.**

- blade length 80 mm and safety lock of opened knife
- special shape of the blade with the hook at the end for cutting of ropes or webbing
- other features: glass cutter, hammer for glass window breaking, opener of electrical cases – wrench
- stainless steel flexible clip for belt fixation

Material:
Blade and clip – stainless steel, plastic handle
Weight: 196 g • 6.9 oz

CULTER

A0050HH00

**Reliable knife for daily work or emergency situations including belt cutter and window breaker.**

- half-serrated 80 mm blade made of 420B stainless steel
- handle made of stainless steel and red G10 fiber
- one hand opening and closing, safety lock
- G10 line of fiber materials is not electrically conductive

- G10 fiber exhibits superior mechanical and dimensional stability and doesn't shrink, it can also resist high temperature (up to 180 °C)

Color: red
Weight: 208 g • 7.34 oz
Material: stainless steel, G10 material

OVERALL

W9803BY



Working overall combining durability, working comfort and maximum freedom of the movement. Specially intended for work at height, easy and quick to take off even without taking the shoes off.

- 60% Polyester / 40% Cotton 250 g / m², 500D Cordura
- bright colors and reflective strips increase the worker's visibility
- high durability even when it's washed at high temperatures (90° C)
- full-length overall with two zippers to guarantee high comfort, practicality and a high speed when putting-on
- adjustable waist for optimum working comfort
- elastic fabric in the armpits and crotch
- two large breast pockets
- on the left sleeve pocket with compartments for mobile phone, pens, small items

- on the left leg extremely large pocket for plans, gloves, etc.
- on the right leg pocket for rescue knife supplemented by two rings of rubber for protection against falling
- on the back zipper pocket for small items
- all pockets marked with bright color for greater comfort
- pants, collar and sleeves ending with adjustable Velcro against heat loss, the penetration of dirt, snow, etc.
- pants tested in the fields of work at height, rescue, arboriculture

Size: S, M, L, XL • EN ISO 13688

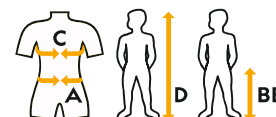

overall			
size	chest C [cm/in]	height D [cm/ft]	length E [cm/in]
S	90/35	172/5.6	102/40
M	94/37	175/5.7	105/41
L	100/39	180/5.9	110/43
XL	106/42	185/6	115/45

note: length after sewing (is added due to shrinkage), shrinkage after washing according to the processing instruction sheet is about 4% of the length

WORKING PANTS

W9801BY



Lightweight and highly flexible pants specially intended for work at heights.

- perfect combination of durability, working comfort and maximum freedom of the movement
- contrast colours and reflective strips increase the worker's visibility
- material ELASTAN guarantees a very high comfort during movement
- jeans low cut for comfortable fit
- higher back for comfortable fit with a working harness
- zippered pockets to secure any items needed in the pocket
- large zippered pocket for mobile phone or small tools, including a loop to secure tools against the fall
- in the side seam pockets for a knife, pencil, screw driver and other small tools
- on the back part deep pocket for any items
- loops for 50 mm wide belt
- large two loops for braces

- front part reinforced with CORDURA
- pants ending with adjustable velcro against heat loss, the penetration of dirt, snow, etc.
- pants tested in the fields of work at height, rescue, arboriculture
- bottoms of the pants are equipped with the mettalic hooks.

Color: black + yellow and reflexive strips

Size: S, M, L, XL

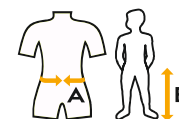
 Material: 98% cotton / 2% elasthan (250 g / m²) + Cordura 500D

working pants		
size	waist A [cm/in]	length B [cm/in]
S	78-82/30-32	105/41
M	82-86/32-34	110/43
L	88-94/35-37	113/44
XL	96-104/38-41	115/45

note: length after sewing (is added due to shrinkage), shrinkage after washing according to the processing instruction sheet is about 4% of the length

T-SHIRTS BACKBONE

man – C1013BB
woman – C1014BB**T-shirts – made of 100 % cotton, short sleeves**

classic round collar

men/women

The T-shirts SINGING ROCK are very comfortable to wear.

size: S – XL

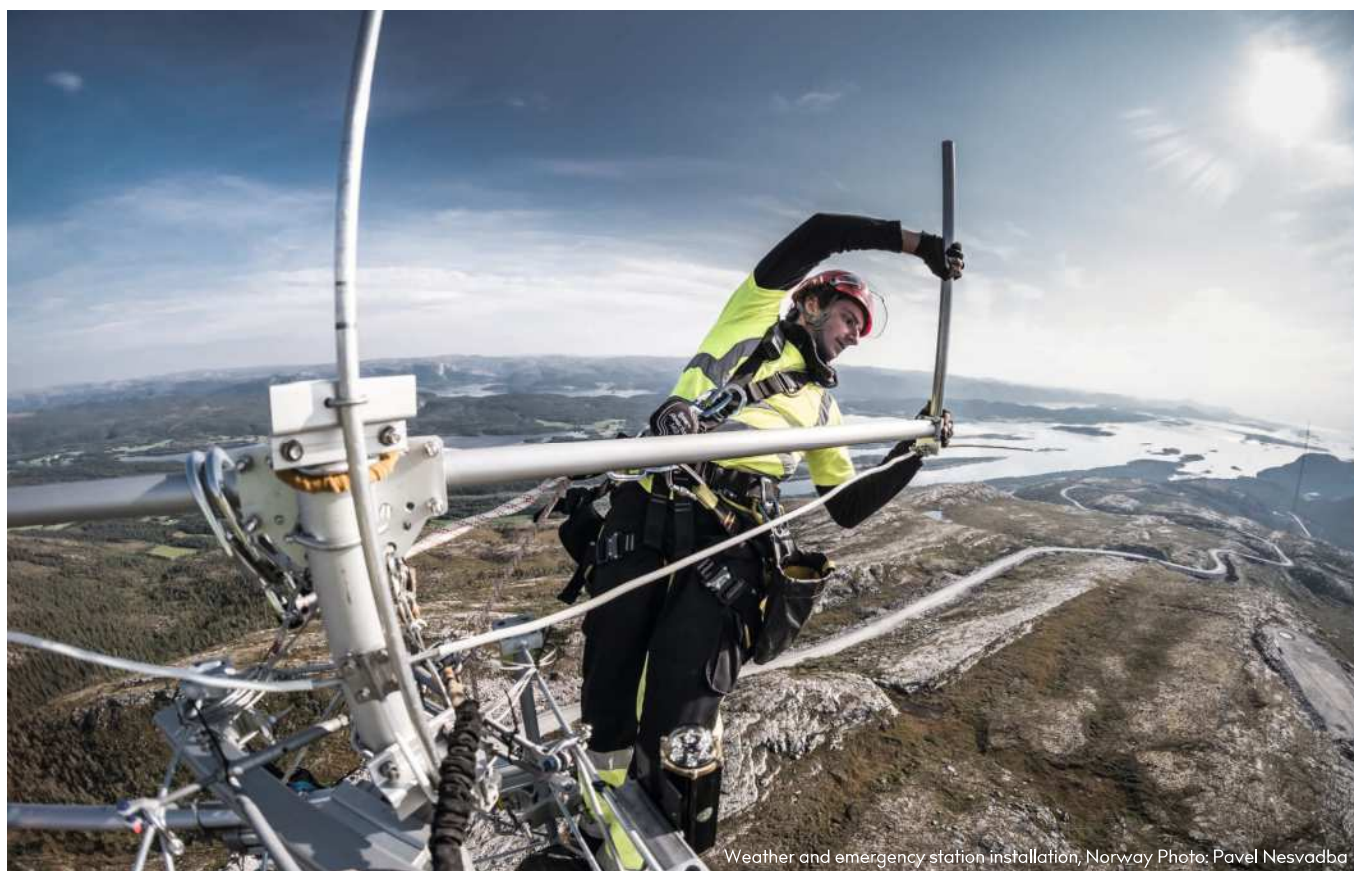
weight: 185 g/m²

Weather and emergency station installation, Norway Photo: Pavel Nesvadba

T-SHIRT BLUE CRACK

man – C1026AX
woman – C1027AX



Made from cotton, double-stitch on sleeve, bottom hems and shoulder to shoulder tape will make this T-shirt last for many years.

Tag less label, relaxed fit. Ladies version with longer and better fit.

Color: Blue

Size: S, M, L, XL

Material: 100% cotton, hems – PES

Weight: 200 g/m²

POLO T-SHIRT

W9802BY



Pique style of polo t-shirt that is sure to look great with any outfit.

The polo features a regular short sleeves and collar with a three button placket for a comfortable fit. The top is finished with split sides and an embroidered Singing Rock logo for an instantly recognizable branded look.

- polo shirt with short sleeves
- regular collar
- Singing Rock branding
- machine washable

Style: UNlsex

Size: S, M, L, XL

Material: 100% pique cotton

HOODY

C1018BY



Warm, cozy and comfortable hoody with a kangaroo pocket and a big hood.

Style: UNisex
 Size: S, M, L, XL
 Material: 90 % cotton,
 10 % soft polyester
 Color: black and yellow

HOODY FULL ZIP

C1019BY – man
C1020BY – woman

Warm, cozy and comfortable hoody with two pockets, hood and full zipper

- longer sleeves and special cut for climbers guarantee maximal comfort when climbing or working at height

Style: Men, Women
 Size: S, M, L, XL, XXL (XXL- man only)
 Material: 90 % cotton, 10 % soft polyester
 Color: black and yellow

SNAP BACK HAT

C0074BY00



Cool Singing Rock cap for your head.

- flat bill
- "singing rock" and the embroidered SR arrow on the front and "climbers for climbers" on the back
- mesh in the back
- adjustable snap strap

BASEBALL HAT

black – C0051BH
brown – C0051HH

Square-shaped visor. Logo on front.
Website singingrock.com on back.

BASEBALL HAT LIGHT

C0070SL00



Cool hat for hot sunny days to cool down your head.

BEANIE



- made from microfibre polyester fabric that keeps its shape well, as well as being breathable, warm, soft and lightweight
- keep your head warm and dry during vertical activities
- fits very well under the helmet
- suitable also for running, skiing, biking and other outdoor activities

Size: S-M, L-XL
Material: 100% Polyester

C0053RX
BEANIE REDHOT

C0053AX
BEANIE AZURE

C0053OX
BEANIE ORANGE

C0054BX
BEANIE LOGOS

C0055BX
BEANIE BLACK ARROW

SCARF

BLACK ARROW – C0079BX00
LOGOS – C0080BX00

AZURE – C0081AX00
REDHOT – C0081RX00



Multifunctional scarf 8 in 1 with a wide variety of uses for your protection against wind and cold.

- can be used as a balaclava, cap, mask, scarf, beanie, shawl, ear warmer, etc.
- 5 different designs to fit all users' styles
- made from elastic high-tech 100% polyester microfibre fabric that keeps its shape well, as well as being breathable, warm, soft, lightweight, of a very high quality and antibacterial.
- machine washable at 30 °C, cannot be tumble dried, air dry very quickly

Size: UNI (approx. 25 cm wide x 46 cm long)
Weight: 35 g • 1.24 oz

BEANIE HAT

C0067BS00
ARROW



A Wool/acrylic mix of beanies, featuring a double layered headband and embroidered design.

- fits well under the helmet
- fleece double layered headband for colder conditions

Size: UNI

Material: wool, acrylic

C0069BG00
NANUK BLUE



C0069PB00
NANUK purple

BELT

C9091XX



for trousers with Rock&Lock smart buckle

Do not use for climbing or work at heights!

Size: M/L, XL

Width: 20 mm

SPEED BELT

black – C9092BX
various colors – C9092XX



Belt for trousers with Speed buckle for fast releasing.

Width: 44 mm

Size: M/L, XL

Color: mixed colors

Do not use for climbing or work at height!

Color: black, khaki, various colors

PITCHER

0.5l – P0010X050
0.3l – P0010X030

Classical beer pitcher 0.5l or 0.3l
for all who likes climbing and all activities on our vertical playground.

MUG

P0012BB00



Thermo cup with sturdy handle keeps your coffee or tea hot.

Capacity: 400 ml • 14.8 fl oz
Weight: 250 g • 8.8 oz

USB FLASH DRIVE

P0019XX00



Wooden flash drive to transport and store your personal files.

- small ring to connect it to your key holder or accessory cord.

Capacity: 8 GB
Material: Eco Friendly wood

KEY HOLDER

P99100X



You will never lose your keys if you use Singing Rock key holders.

WRISTBAND

P0024XX00



100% latex-free silicone wristband with debossed Singing Rock. Made from premium high quality rubber.

TEXTILE BADGE

10x4 cm – P0031XX01
15x6 cm – P0031XX02



Singing Rock textile embroidered badge to be stitched to your clothing, backpack or bag.
Size: 10 x 4 cm, 15 x 6 cm

BAG

P0026XX00



Eco-friendly plastic bag.
This bio degradable bag contains the special additives which help the bag to break down into natural compounds when disposed.

Dimensions: 39 x 46 cm



NOTEPAD A5

P0030XX00

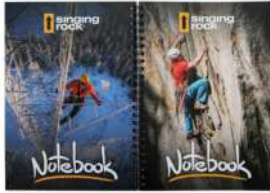

Manage your important tasks or jot down your to-do list with our Singing Rock notepads.

CONDOM

P0023XX00

**Safety first**

Your Personal Protective Equipment for your hardware.

Size: UNI

EN ISO 4074, CE 1023

SINGING ROCK PEN

P0022XX00



Ballpoint pen for everyday writing.

BANNERS

P0020



Singing Rock banners made from lightweight PES with a holes to hang up.

Size:
 P0020BB02
Small: 60 x 60 cm
 P0020BB03
Medium: 30 x 150 cm
 P0020BB04
Large: 200 x 100 cm
 P0020BB05
XLarge: 150 x 150 cm

BEACH FLAG

P0021



Self standing event flag. Made from elastic PES. Comes with a footstand and carrier bag.

Size:
 P0021BB00
Table: 29 x 60 cm
 P0021BB03
Medium: 60 x 260 cm
 P0021BB04
Large: 80 x 340 cm
 P0021BB05
XLarge: 85 x 450 cm

SINGING ROCK STICKERS

P0025XX00

with back and front side adhesive.



TECH INFO EN

P0028WE00

POSTERS

P0027WX00

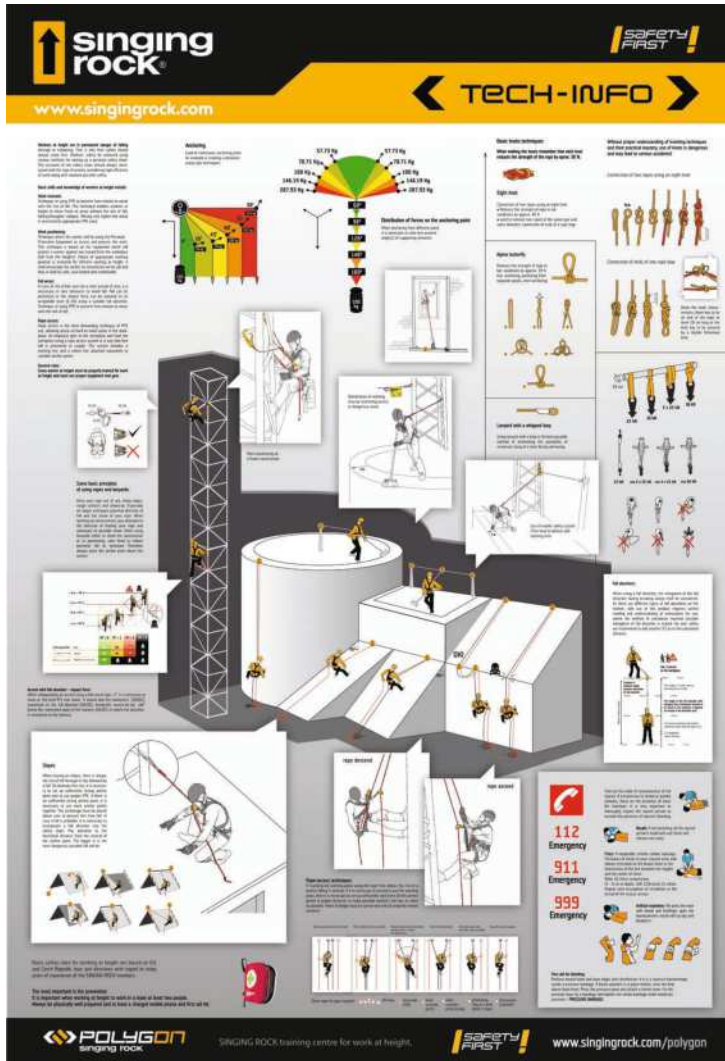

690x990 mm



Image posters with our gear in action.

- 1. Water Treatment 480x690 mm
- 2. Light Tower 480x690 mm
- 3. Karolina vertical 480x690 mm
- 4. Castle 480x690 mm
- 5. Karolina 690x480 mm
- 6. Tree Care 690x480 mm
- 7. Silo 480x690 mm
- 8. Tower Sweden 480x690 mm
- 9. Helicopter Sweden 480x690 mm



Work at height

Workers at height are in permanent danger of falling from a height. That is why their safety should always come first. Worker's safety is achieved by using various methods for setting up a personal fall protection system. The structure of the fall protection system should always correspond with the type of activity considering high efficiency of work along with maximal possible safety.

Basic skills and knowledge of workers at height include:**Work restraint:**

Technique of using PPE to prevent from motion to areas with the risk of fall: This technique enables workers at height to move freely to areas without the risk of fall, falling-through or collapse. Moving into higher-risk areas is restricted by appropriate PPE used.

Work positioning:

Technique where the worker will be using the Personal Protective Equipment to access and process the work. This technique is based on the equipment which will protect a worker against any hazard from the workplace (fall from the heights). Choice of appropriate working position is essential for efficient working at height. It shall encourage the worker to concentrate on his job and thus it shall be safe, sure-footed and comfortable.

Fall arrest:

In case of risk of fall, even for a short period of time, it is necessary to take measures to avoid fall. Fall can be prevented or the impact force can be lowered to an acceptable level (6 kN) using a suitable fall absorber. Technique of using PPE to prevent from motion to areas with the risk of fall.

Rope access (part off work positioning)

Rope techniques place high demands on the skills and abilities of worker at height. The basis for safe handle of rope techniques is adequately selected PPE and proper training of worker at height.



SERVICE & ACTIVITIES

POLYGON TRAINING CENTRES
PAPER TRAIL PPE MANAGEMENT
SCAFOLDERS AND INDUSTRIAL HALLS
FRAMING AND ROOFING
FALL ARREST
ROPE ACCESS
LADDERS
TREE CARE
ROPE COURSES AND ADVENTURE PARKS
WIND TURBINES
CHAIR LIFT EVACUATION
MILITARY AND SPECIAL FORCES

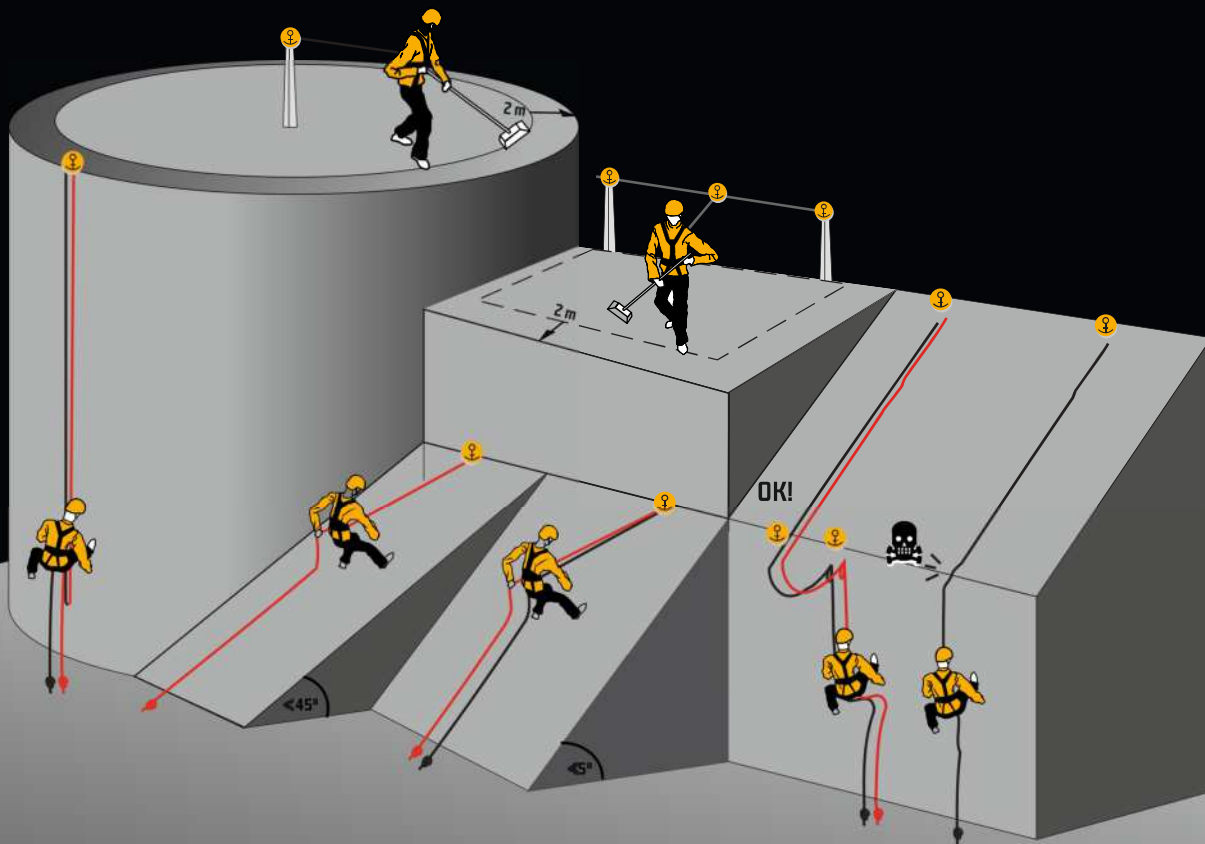

POLYGONS



SINGING ROCK is certified as IRATA training company.

SINGING ROCK is the first and so far the only company in the Czech Republic to become a member of the globally recognized association IRATA.

IRATA – Industrial Rope Access Trade Association – was founded in the UK in order to ensure a safe working environment for workers at height. In a quarter of century of its existence, IRATA has become a leading expert in the field of security in work at height, and in this field it is the only global association with many member organizations around the world.

Our operated IRATA courses therefore provide, in conjunction with our certificated POLYGON training centers, a unique opportunity to obtain the best possible qualification for work at height and above depth. After successful completion of the training the participant receives an IRATA certificate, which is valid around the world and which is required by some foreign entities as the only possible prerequisite to carry out work at height.

Over more than two decades on international markets, SINGING ROCK has become the world's leading manufacturer of Personal Protective Equipment (the "PPE"). In an effort to provide its customers with comprehensive services and solutions in the area of security of workers at height and above depth, SINGING ROCK was the first in the Czech Republic and former eastern Europe to build a completely unique multifunctional training center POLYGON.

POLYGON facilities create the ideal conditions for providing occupational health and safety (the "OHS") training for work at height and

above depth, for testing PPE, for organizing industrial climbing contests and many other events associated with presentation and use of products and techniques related to this area. A number of specific simulations allow visitors to test safely proper techniques of safeguarding when working at height. All this under the direct supervision of experienced trainers while using complete equipment for these activities. With individual approach, high quality equipment and great emphasis on the practical part, our trainings in POLYGON became sought after among individuals and companies not only in the Czech Republic.

FISAT

Professional Organization for Rope-Assisted Work Techniques – FISAT e.V. is the professional organization for everyone involved in trades involving the use of rope for rescue and work. On this site, we provide extensive information on professional rope access and climbing techniques, from safety guidelines and training to certification exams for rope access

technicians. Our input in various panels and working groups benefits the continual further development of working techniques as well the constant improvement of safety in this field of work. SINGING ROCK is associated member of this organization a provides full service for everyone involved in work at height training.



SINGING ROCK is a member of FISAT organization



LIST OF SINGING ROCK POLYGON TRAINING CENTERS



POLYGON Poniklá, Czech republic

Our first POLYGON is part of the SINGING ROCK headquarter and manufacturing factory in a picturesque valley of the Jizera river. It offers a number of model situations for work at height.

www.singingrock.com/polygon



POLYGON Kladno, Czech republic

located in the former premises of Poldi Kladno – Konev. The former manufacturing building offers a real industrial environment to practice work situation when working at heights.

www.singingrock.com/polygon



Polygon Partner Brno, Czech republic

Located in an industrial area in a former cement plant. Thanks to its height of more than 23m, it gives the opportunity to create a variety of model situations for work at height and rescue training.

www.kladna.cz/skoleni-prace-ve-vyskach-bozp



Polygon Partner Ostrava, Czech Republic

Training centre situated in the unique historical industrial site where for more than 150 years thousands of miners used to mine a black coal.

www.polygonhlubina.cz



Polygon Partner Karlovy Vary, Czech republic

Until recently, the Karlovy Vary region, situated in the west of the Czech Republic, didn't have a professional training centre for work at height. It was changed in May 2019. Now, this new POLYGON partner offers high-quality services to all applicants from that part of our country.



Polygon Partner Lisbon, Portugal,

This training center has the perfect conditions to provide all trainings for work at height including rope access, fall arrest, rescue and PPE inspection.

outprowork.com



CZECH REPUBLIC

Polygon:
Poniklá
Kladno
Karlovy Vary

Polygon Partner:
Brno
Ostrava
Ústí nad Labem
Karlovy Vary



ITALY

Polygon Partner: **Milan**



ROMANIA

Polygon Partner: **Brasov**



BULGARIA

Polygon Partner: **Sofia**



PORTUGAL

Polygon Partner: **Lisboa**

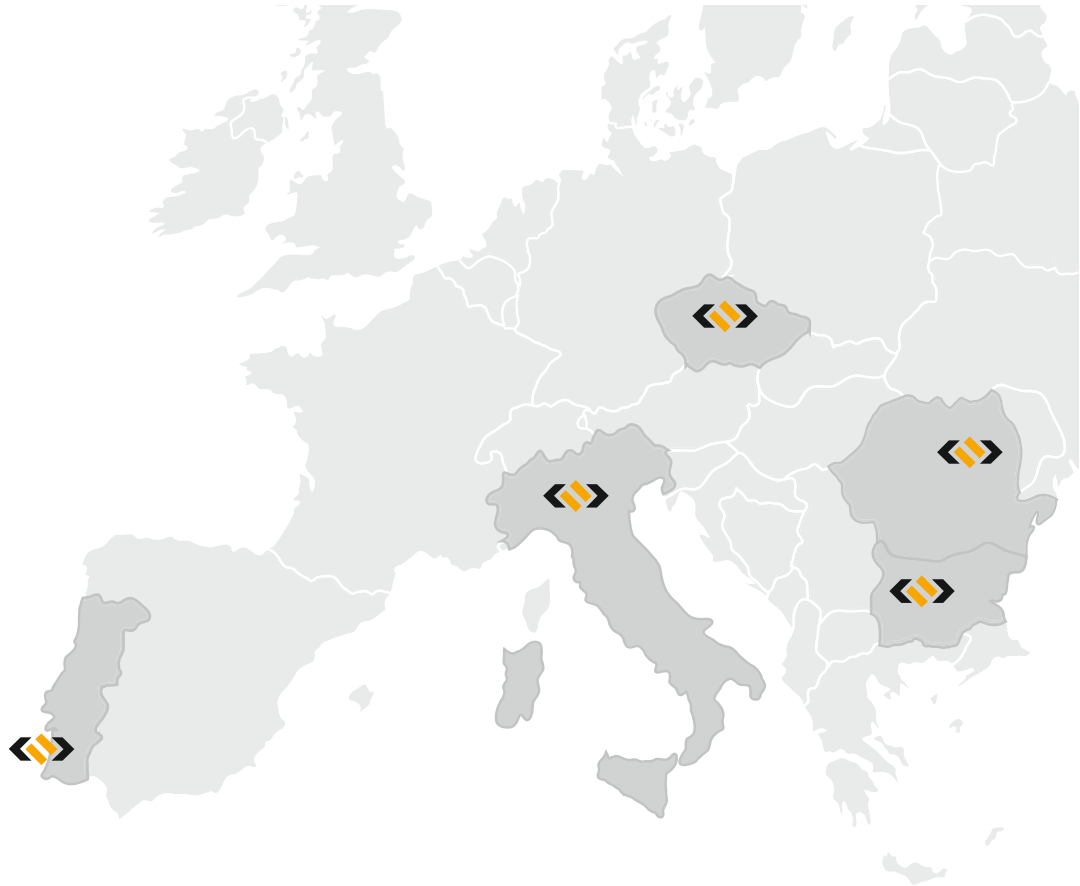

Polygon Partner Milan, Italy

Training center dealing with Occupational Safety Prevention, dealing with 360 degree training for all figures identified by the Single Word „Health and Safety at Workplaces“, ranging from general training on specific training such as high risk falls, confined spaces, work with rope access and positioning systems, assembly and dismantling scaffolding and use of work equipment.

www.mbtectum.it



Polygon Partner Brasov, Romania

This training centre is the first provider of training courses in work-at-height in the south-east of Europe. The centre is evolved through the volume of it's services, the number of technicians and most importantly through it's techniques in providing rope access services.

www.e-solo.ro



Polygon Partner Sofia, Bulgaria

Training centre situated in Sofia is operated by PROFIXT Ltd, IRATA # 6026/T which has been providing work at heights trainings and IRATA trainings for over 10 years in Bulgaria and has certified more than 400 industrial rope access technicians by the standards of the international system of IRATA.



WHAT IS IT?

Personal Protective Equipment (PPE) must be regularly inspected for safety and compliance purposes, but as the volume of equipment grows this can put a strain on administrative resources. At the same time, there is a growing need to be able to demonstrate Health and Safety (H&S) compliance in the event of an incident. Against this backdrop, large PPE users are finding that traditional, often paper-based methods of record management are insufficient for their needs.

If your job is to keep track of lots of equipment then you face an uphill struggle. And if you have equipment that needs to be tested or inspected on a regular basis, the job is even bigger. Try as you might, records get lost. Inspections are forgotten. Equipment goes missing.

Wouldn't it be easier if you could store all your equipment information in one place? Somewhere easy to get access, such as in the cloud? And easy to search, use and update? Available from desktop, tablet or smart phone. That's Papertrail, an all-in-one system for equipment management and maintenance records.

HOW DOES IT WORK?

Anything with a serial number, barcode or RFID tag can be tracked and the data sits securely in the cloud, where it can be made available to internal teams or customers, as required.

To register any product, you need to create a new record with a unique number and corresponding product information, initiate inspection frequency and instructions for inspections. The system will track all the changes during the lifetime and send automated reminders about upcoming inspections.

Singing Rock has uploaded to the cloud thousands of products with detailed information about:

- Name
- Category
- Description including colour, size and weight
- Photo
- EN conformity
- Product code
- Identifier
- Serial number
- Barcode number
- Date of manufacture
- Lifespan
- Inspection frequency
- User instructions
- Inspection instructions

Simply scan a Data Matrix Code from the label using any camera on your mobile phone, notebook or barcode reader or type a serial number to register, track and inspect our products.

WHAT ARE MY BENEFITS?

Being proactive is rarely easy with the systems that most companies currently use for PPE management. However, record keeping on commercially available spreadsheet software, such as Microsoft Excel, is still the norm, and in some cases smaller PPE asset holders may even keep their records on paper.

Paper-based records are hard to access and prone to loss and damage, while spreadsheet-based systems entail significant administration effort.

The Papertrail platform enables remote data entry to create a permanent, one-time, cloud-based record of each PPE item, which can then be updated at any time with inspection records posted on site via a mobile device. Each record is time-stamped and can be accessed instantly, from anywhere, allowing asset owners to call up relevant compliance information whenever and wherever needed. Features of a smart PPE management system include:

- Easy compliance with legal requirements for six-month or annual inspections and an up-to-date status of PPE which can be accessed via a dashboard, with records for each item and built-in reporting for major regulations.
- Compatibility with all iOS and Android mobile devices and the ability to set notifications to suit any given asset, making it easy to trigger follow-up actions such as repeat inspections or warranty checks.
- Optional customisable inspection schedules, status reports, certifications, export options, workflows, integrations, task management, check lists and care and maintenance schedules.
- Easy integration with equipment manufacturers and compatibility with any brand or component with a serial number, barcode or RFID tag.
- Implementation that does not require any additional hardware and gives you access to the data you need at any time, from the cloud.
- Customisable configuration and implementation, training, reporting, IT support and additional PPE inspection services.

Papertrail is integrated with Singing Rock inventory database so equipment data can be imported seamlessly and easily.



This integration allows equipment owners to create and maintain a 'digital certificate of ownership' that registers every significant point in the lifespan of an item, from purchase through to disposal. Such certificates could be invaluable in quality control, for example in helping prevent the sale of fake items or in giving reassurance to buyers of second-hand material.

- Save time and effort by filing equipment inspection records on the spot, and making them instantly available to your colleagues.
- Wave goodbye to paper records and spreadsheets, and let our software take care of your equipment record filing needs.
- View and update equipment records easily from wherever you are, using mobile devices such as handheld scanners.
- Show compliance at all times with a system that can prove when every single inspection was carried out.
- Never lose an equipment record by storing all updates securely in the cloud.

Companies adopting a smart PPE management system are expected to improve their ability to:

- Comply with the demands of professional bodies such as the Industrial Rope Access Trade Association and the Society of Professional Rope Access Technicians.
- Meet standards for UK Lifting Operations Lifting Equipment Regulations, Provision and Use of Work Equipment Regulations and other legal inspections.
- Cut compliance administration by scheduling automatic reminders for daily, weekly, monthly and annual inspections. Reduce risk for clients and workers by making sure they are not using faulty or out-of-date PPE.
- Prevent equipment supply bottlenecks by having a complete view of the status of all PPE stock.
- Extend the lifetime of PPE equipment by ensuring it is reviewed and repaired periodically.
- Show compliance at any time with a complete service history for each item of PPE.

Companies worldwide use Papertrail and your staff and customers can access the data they need at any time, from the cloud. Users of the Papertrail smart PPE management system have reported more than a 90% reduction in administration workload, along with reduced human error and increased equipment use.

If you are keen to improve your PPE management system the best way is to download Papertrail application, sign in for the account and simply administrate your PPE.

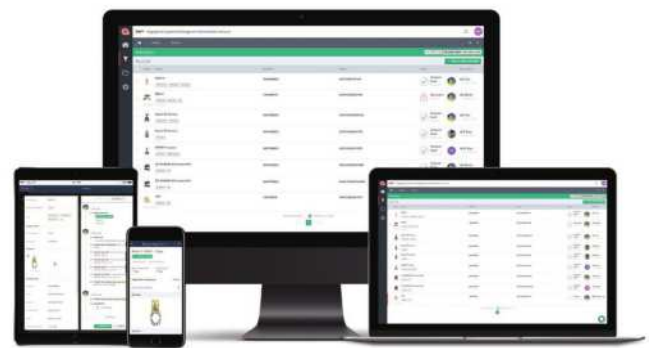

papertrail 
Record keeping made simple



FALL FACTOR

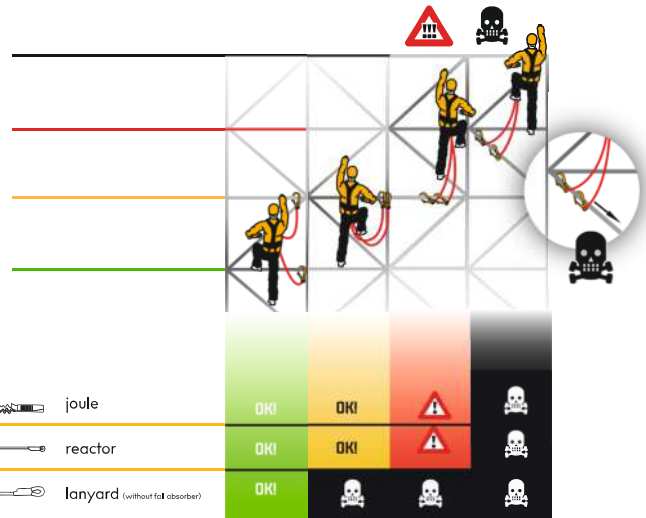

When safeguarding an ascent using a fall arrest type „Y“ it is necessary to move at the level FF1 and lower. It means that the connectors (EN362) connected to the fall absorber (EN355) during the ascent do not „fall“ below the connection point of the harness (EN361) in which the absorber is connected to the harness.

basic skills

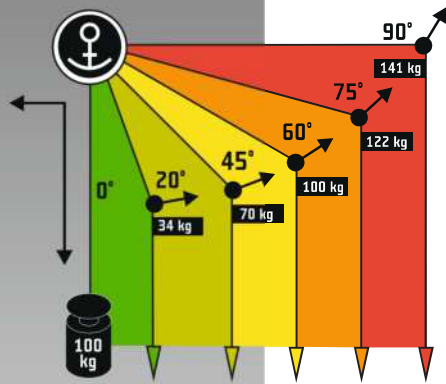

Load of continuous anchoring point. An example is creating a deviation using rope techniques.

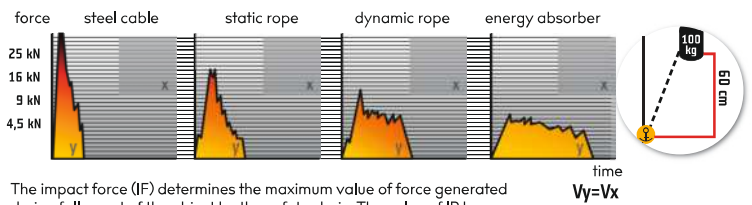

The impact force (IF) determines the maximum value of force generated during fall arrest of the object by the safety chain. The value of IP has a direct impact on the safety of worker at height. Ideally, we avoid IP if we reduce it to the lowest level possible (max 6kN)

ANCHORING

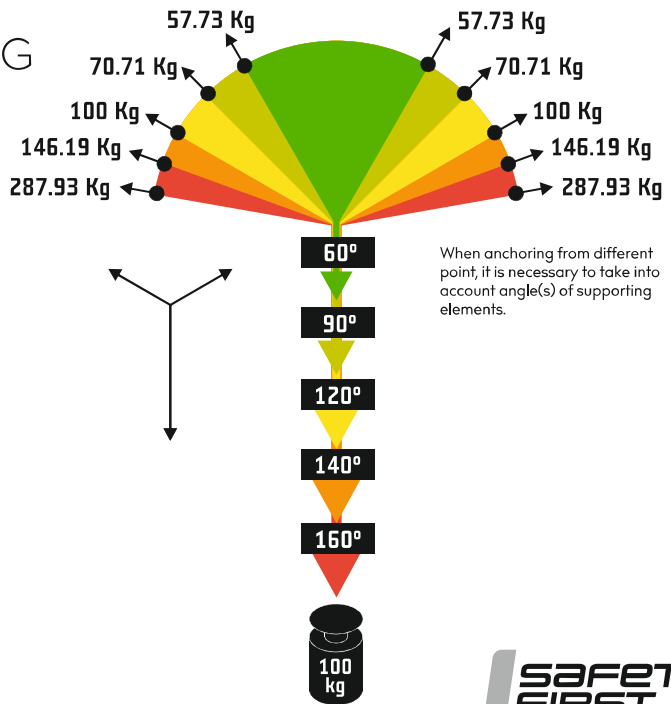
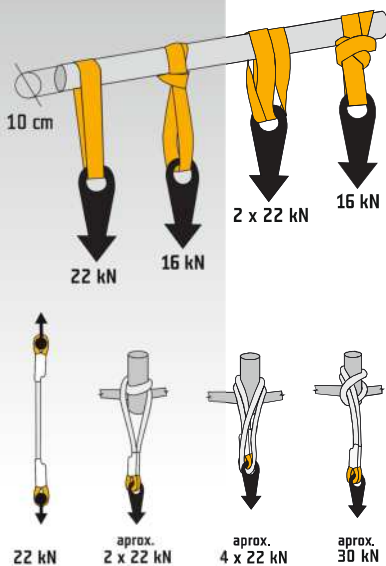

When anchoring from different point, it is necessary to take into account angle(s) of supporting elements.





Connection of two ropes using an eight knot

Figure-Eight knot

Connection of two ropes using an eight knot

- Reduces the strength of rope in lab. conditions by approx. 46%
- used to connect two roped of the same type and same diameter; connection of ends of a rope loop

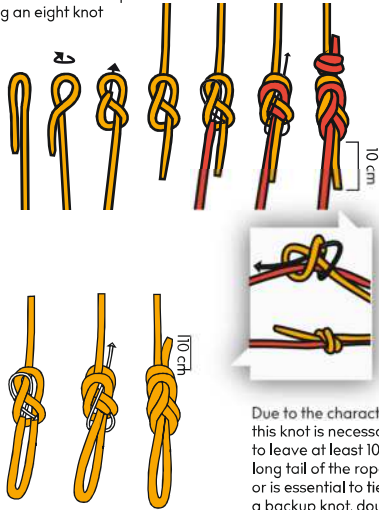

Due to the character of this knot is necessary to leave at least 10 cm long tail of the rope or is essential to tie a backup knot, double fisherman's knot

Connection of ends of one rope loop

CONNECTING KNOTS

Double fisherman knot

Connection of two ropes using a double fisherman knot

- Reduces the strength of rope in lab. conditions by approx. 32%
- connection of two ropes (rope loops) of different type or diameter

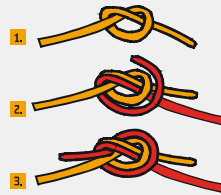
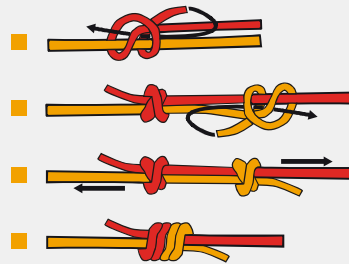

Overhand follow through
Used to join two ropes or slings together. When loaded it is harder to untie it.

FRICTION KNOTS

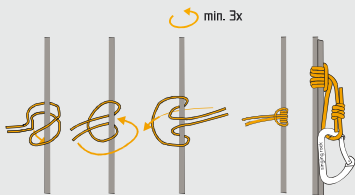

Prusik knot

Simple and the easiest friction knot. It works in both directions. Normally made from accessory cords 5-6 mm diameter. It is possible to make it with one hand only. Note: the joining knot must be kept away from the rope to prevent slippage.

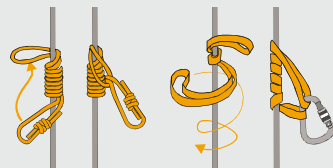

Klemheist (Machard) knot

Works very well, suitable also for flat slings, it's possible to make it also from thicker diameter slings (up to 9mm).

BELAY KNOT



Munter hitch

Knot used for belaying with HMS carabiner. There is no static friction on any part of the rope as it is a continuously moving knot. It is easy to tie even with one hand or with the gloves on the hands. The part of the rope going to belayer must not go through the gate of the carabiner.

ANCHORING KNOTS

Clove hitch

Reduces the strength of rope in lab. conditions by approx. 12%

Use: anchoring
It is possible to make it with one hand only, it is easy to untie after the loading

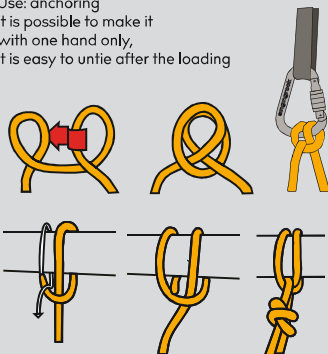

Due to the character of this knot is essential to tie a backup knot, double fisherman's knot.

Double figure eight loop

(Bunny Ears)
Very useful for equalizing the load on two anchor points.

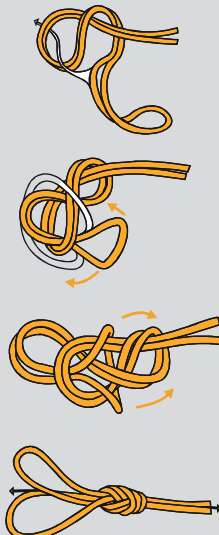

Lanyard with a whipped loop

Using lanyard with a loop is the best possible method of eliminating the possibility of erroneous tying of a knot during anchoring.

Alpine butterfly

Reduces the strength of rope in lab. conditions by approx. 39%

Use: anchoring; anchoring from separate points, inter-anchoring.

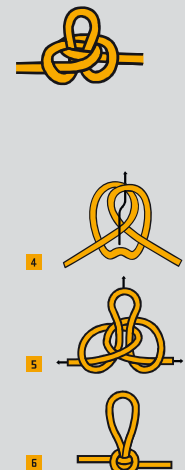



scaffolders and industrial halls

Many people are injured each year when they fall from scaffolders. Scaffolders should be erected by trained and competent people. There are a number of organisations that provide training for the safe use of scaffolders. A scaffolder is one way to prevent a fall when working at height. The type of scaffolder selected must be suitable for the work and erected and dismantled by people who have been trained and are competent to do so. Those using tower scaffolds should also be trained in the potential dangers and precautions required during use. Tower scaffold provision and use must be properly managed and include rigorous scaffold inspection arrangements.

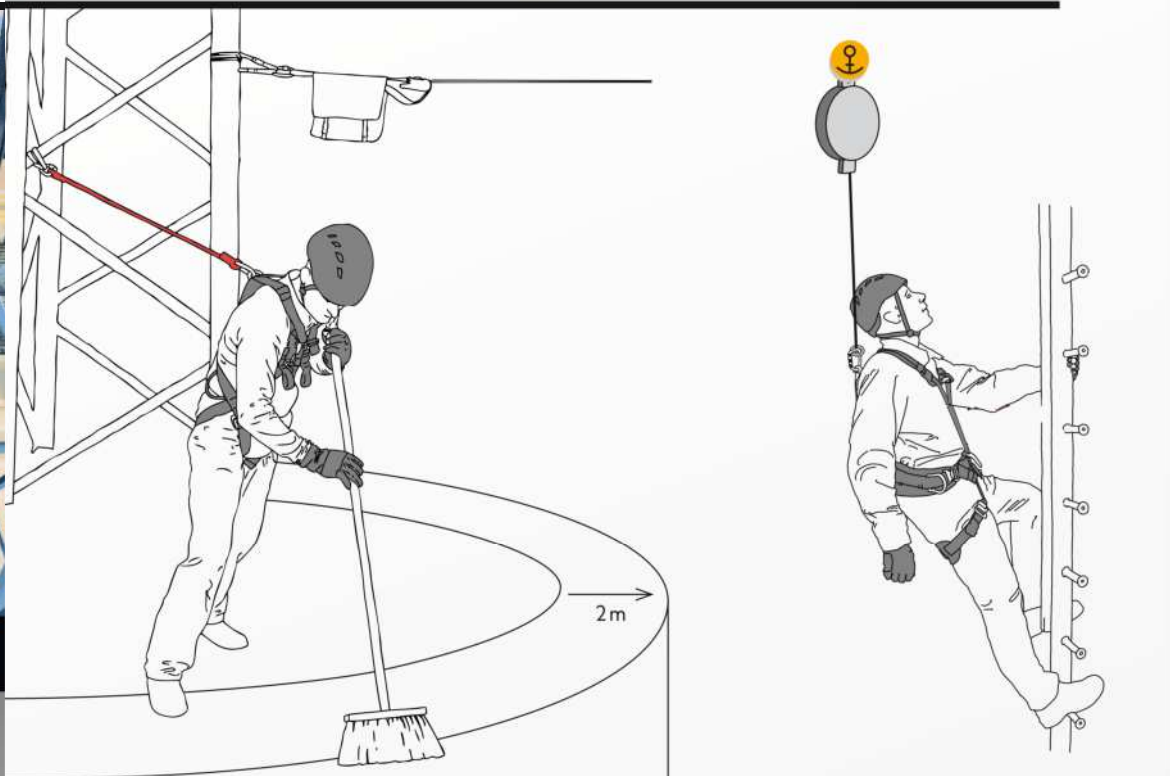

Delimitation of working area by restricting access to dangerous areas.



Use of mobile safety system (Fine line) to delimit safe working area

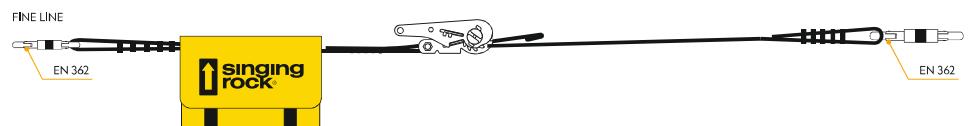
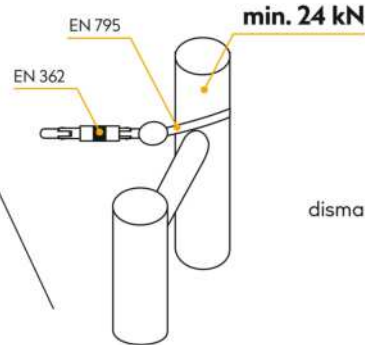
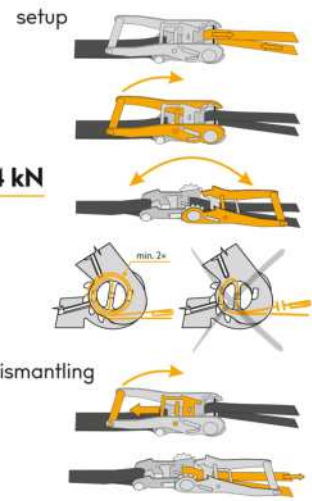



W2001
OPEN SLING
sewn sling, 120cm

W4100Y120
JOULE 120
the fall absorber
120 cm

W9601
FLASH INDUSTRY
working helmet

K4241Z005
OVAL STEEL
CONNECTOR
screw

ADJUST
W1047Y10C
adjustable
lanyard

K0122EE05
OXY screw
light alloy
oval carabiner

W0068BR
BODY II speed
fall arrest harness

W1010BB09
LOCKER
guided type fall
arrester

RK850X100
STEEL
LANYARD „I”
130 cm

K82310Z
MAILLON BOG D
steel maillon
carabiner

A4000S
IKAR HWS
Retractable fall
arrest system

L0041 – L0081
ACCESSORY CORD
6 mm, 20m

S9000BB50
GEAR BAG
waterproof bag

X0075XX14
BANTAM BEAMER

W1011WB02
SITE
work positioning
lanyard

SCAFOLDER SET



M0021XX
Scaffolder set is intended for those, who install scaffolds or work on tall structures and towers. It allows you to reach safely a place of work and position there for work.



framing and roofing

When moving on slopes, there is always the risk of fall-through or slip followed by a fall. To eliminate this risk, it is necessary to set up sufficiently strong anchor point and to use proper PPE. If there is no sufficiently strong anchor point, it is necessary to use more anchor points together. The anchorage must be placed above user to prevent him from fall. In case a fall is probable, it is necessary to incorporate a fall absorber into the safety chain. Pay attention to the horizontal distance from the vertical of the anchor point. The bigger it is the more dangerous possible fall will be.

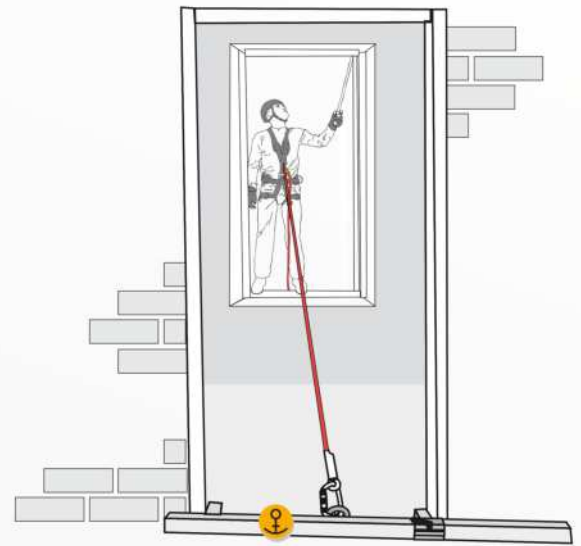

Any fall from a roof inevitably involves at least a serious injury. The risks are substantial, however long or short the work is. Getting on and off the roof is a major risk.

A secure means of entry and exit is essential.

A general access scaffold or tower scaffold (preferably of the stairway design) will provide suitable access. A properly secured ladder is the minimum requirement.

Roof workers need the appropriate knowledge, skills, training and experience to work safely, or should be under the supervision of someone else who has it.

They need to be able to recognise the risks, understand the appropriate systems of work and be competent in the skills to carry them out. Workers need training and experience to achieve these competencies. It is not enough to hope that they will 'pick up safety on the job.'

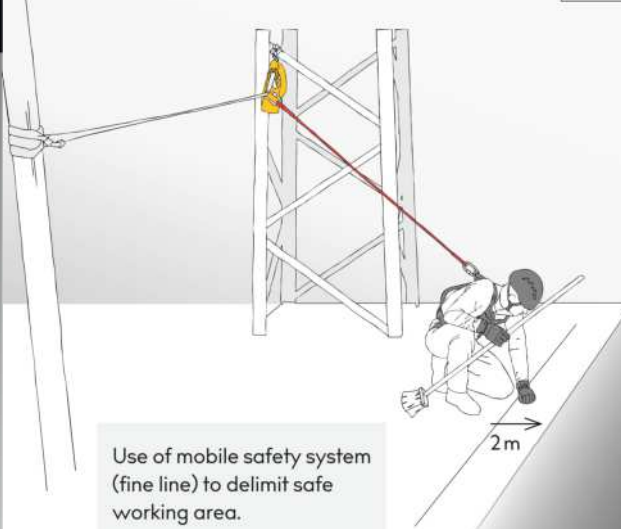

Use of mobile safety system (fine line) to delimit safe working area.

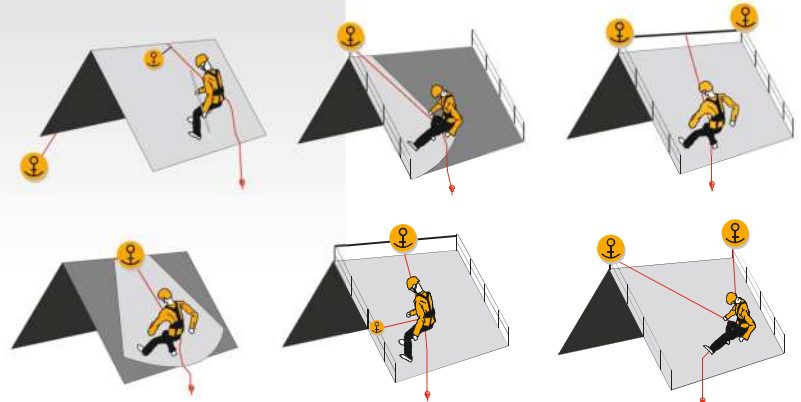
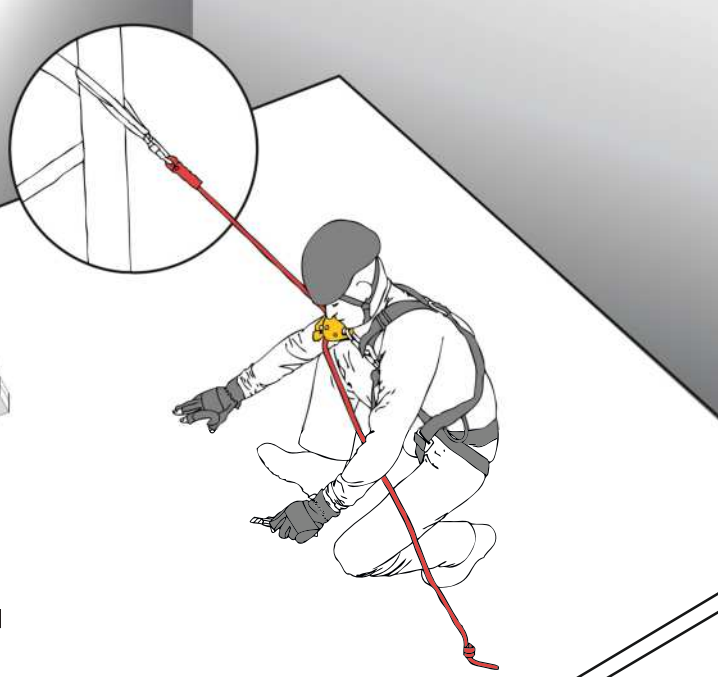

W8100B
**ROPE
PROTECTOR**



W9603RX
**FLASH
ACCESS**
working helmet



K4241Z005
**OVAL STEEL
CONNECTOR**
srew



K0122EE07
OXY triplelock
light alloy oval
carabiner



K4241Z007
**OVAL STEEL
CONNECTOR**
triplelock



W0091BY
ROOF MASTER
Lightweight and fully
adjustable full body
harness



W2016*080
**SLING
LANYARD**
sewn sling



W1010BB09
LOCKER
guided type fall
arrester



C0012YB
FALCONER FULL



W0008BS
TOOL BAG



W1001WW10
FINE LINE
mobile anchoring
system



W1001WS10
FINE LINE BAG
mobile anchoring
system bag



L0250RR
Static 11.0
red



ROOFER SET



M0020X1 – Roofer set 10 m, M0020X2 – Roofer set 20 m
Roofer set 10 is ideal for those, who are fully devoted to roofing. It allows you to position yourself on a roof with up to 45° angle to prevent a possible fall due to slippage or breaking of a structure.

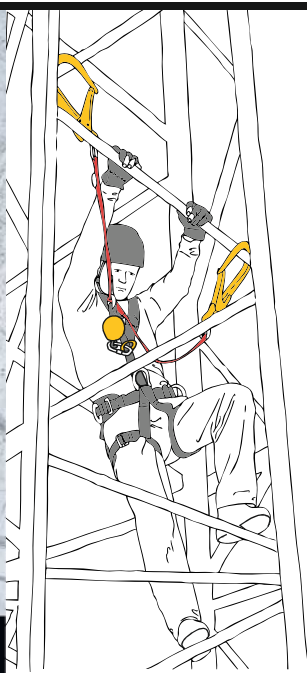

Some basic principles of using ropes and lanyards:

Keep your rope out of any sharp edges, rough surfaces and chemicals. Especially on slopes anticipate potential direction of fall and the strain of your rope. When working on constructions, pay attention to the direction of leading your rope and anticipate its possible strain. When using lanyards either to climb the construction or to positioning, take heed to reduce potential fall to minimum! Therefore always place the anchor point above the worker.

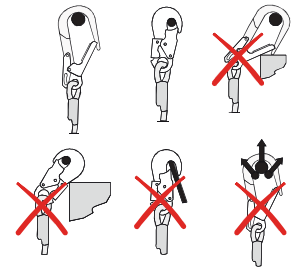

towers and rigging

- Working on tall structures may involve fall arrest, work positioning, rope access and possibly evacuation.
- If no stable safety system is present and the structure needs to be climbed repeatedly a flexible fall arrest line may be required
- For climbing on the frame construction of metal towers fall absorber may be essential.
- Construction demands a full range of fall protection solutions to meet the needs of a dynamic workplace. That's why workers turn to SINGING ROCK for expertise, superior quality products and continual systems innovation.

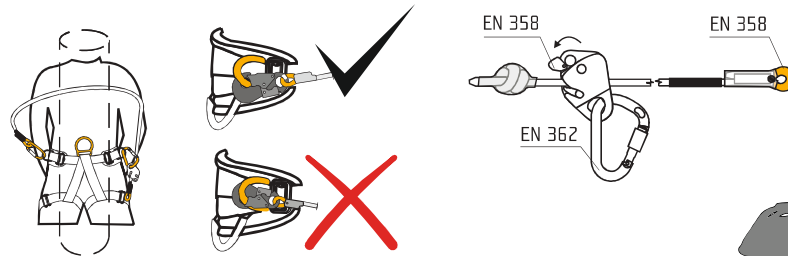
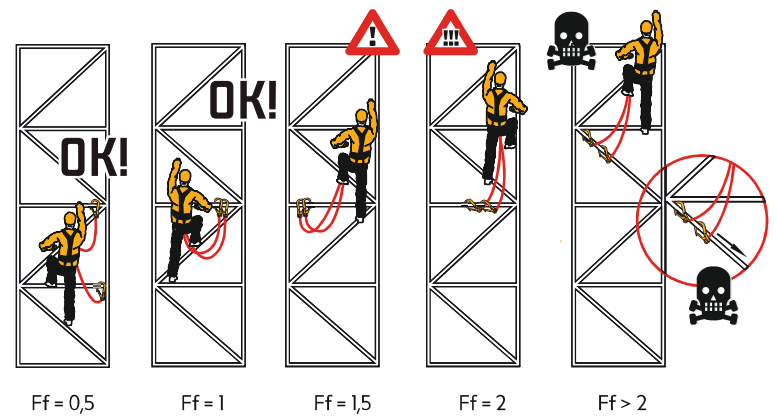

Fall absorbers:

When using a fall absorber, the elongation of the fall absorber during breaking action shall be considered. As there are different types of fall absorbers on the market, safe use of this product requires careful reading and understanding of instructions for use, where the method of calculation maximal possible elongation of fall absorber is stated. For your safety we recommend to add another 0.5m to the calculated distance.

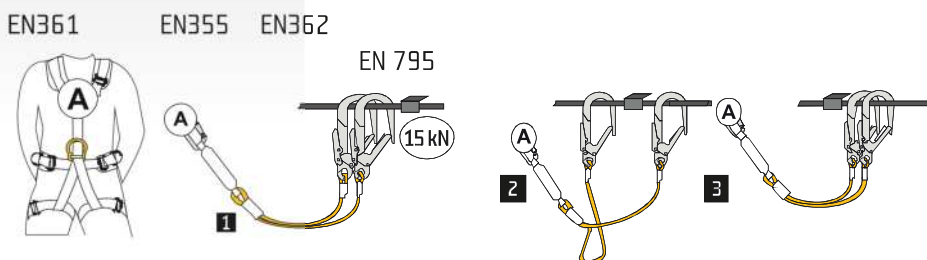

Work positioning on a frame construction

W9603RX
FLASH ACCESS
working helmet



C006BH
GRIPPY
leather gloves



W1010BB09
LOCKER
guided type fall arrester



K0122EE07
OXY triplelock
light alloy oval carabiner



W008IDR
PROFI WORKER 3D
standard fully adjustable fall arrest and rope access harness



K4241Z005
OVAL STEEL CONNECTOR
triple lock



W2001
OPEN SLING
sewn sling



K9000BB03
PORTER
plastic holder



W2016*080
SLING LANYARD
sewn sling



W4400WW00
REACTOR 140
shock absorber



W1012WB
SITE + K370
work positioning lanyard



W0052B010
WORKING BAG
transport bag for working harness





rope access

Rope access is called "royal discipline" in working at height activities. This working method is fast, effective, has little effect on the workplace and it is very quick to install and dismantle. It is used for a wide variety of work: cleaning, painting, inspection and other working situations.

Where is rope access used?

There are five main areas in which rope access companies operate (and examples of the range of work carried out):

- Inspection and Testing Safety surveys
- Maintenance and Repair Sealant installation and reinstatement
- Cleaning and Painting Jet spray, grit blast and three-tool method
- Geotechnical (Civil Engineering) Permanent rock anchorage
- Construction Cladding

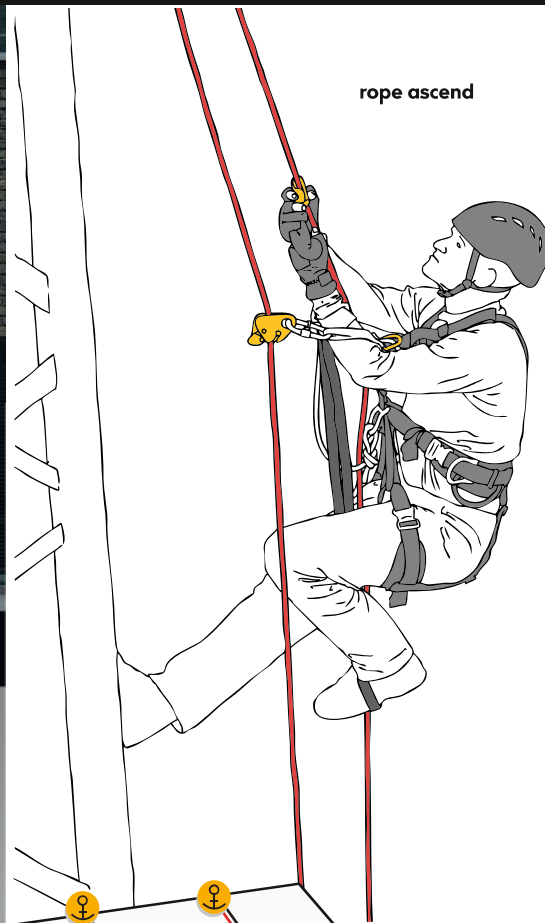

rope ascend

Rope-access techniques:

If reaching the working place using the rope from above, the risk of a worker falling is minimal. If it is necessary to ascend to use the working place, then it is necessary to set up sufficiently solid anchor points in proper distance, to make possible worker's fall was as short as possible. Work at height must be practised only by properly trained workers! When using climbing techniques the first climber is safeguarded indirectly. The locking device is incorporated in a sufficiently solid anchor point outside the body of the safe guarder. An advantage is the possibility of providing first aid to the first climber in a relatively short time.

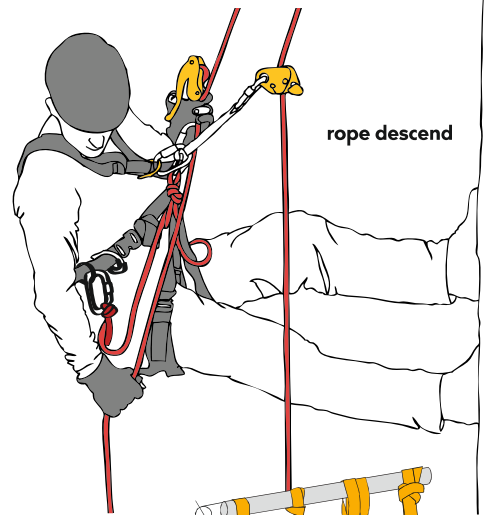

rope descend

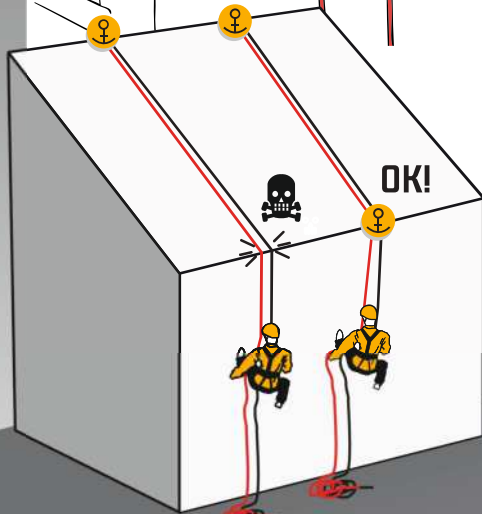

Lanyard with a whipped loop
Using lanyard with a loop is the best possible method of eliminating the possibility of erroneous tying of a knot during anchoring.

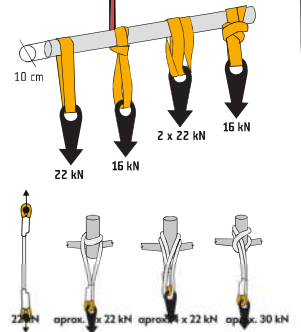

Working position with a descender.

Place hand and chest ascenders.

Position body into the descender and ascenders, re-place the fall arrester.

Take off the descender.

Place descender and take off a chest ascender.

Take off a hand ascender.

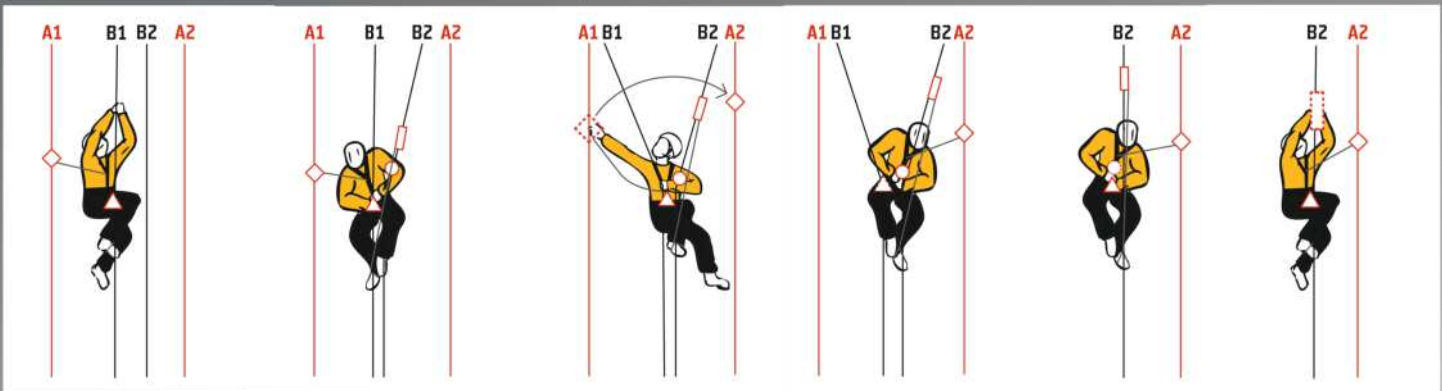

L0450WG
**STATIC
R44 T1.0**
static rope



W9603RX00
FLASH ACCESS
working helmet



RK804BX0R
LIFT
hand ascender



RK805BX00
CAM CLEAN
Chest ascender



L0450RR
**STATIC
R44 T1.0**
static rope

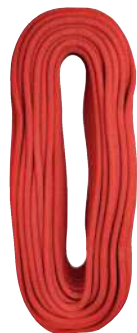

K032SIR00
SIR
multipurpose device
for rope access



W1010BB09
LOCKER
guided type fall arrester



W0079DR
**EXPERT 3D
speed**
fully adjustable
rope access
harness



W8100B
**ROPE
PROTECTOR**



W1015B020
LOCKER SLING
certified sling for the Locker



K00500S03
EDGE ROLLER
rope protector



K424IZ005
**OVAL STEEL
CONNECTOR**
triple lock



W2001
OPEN SLING
sewn sling



RK801EE00
PULLEY EXTRA
durable and lightweight
pulley



W0010YB
FRANKLIN
work positioning
seat



K0122EE07
OXY triplelock
light alloy oval
carabiner







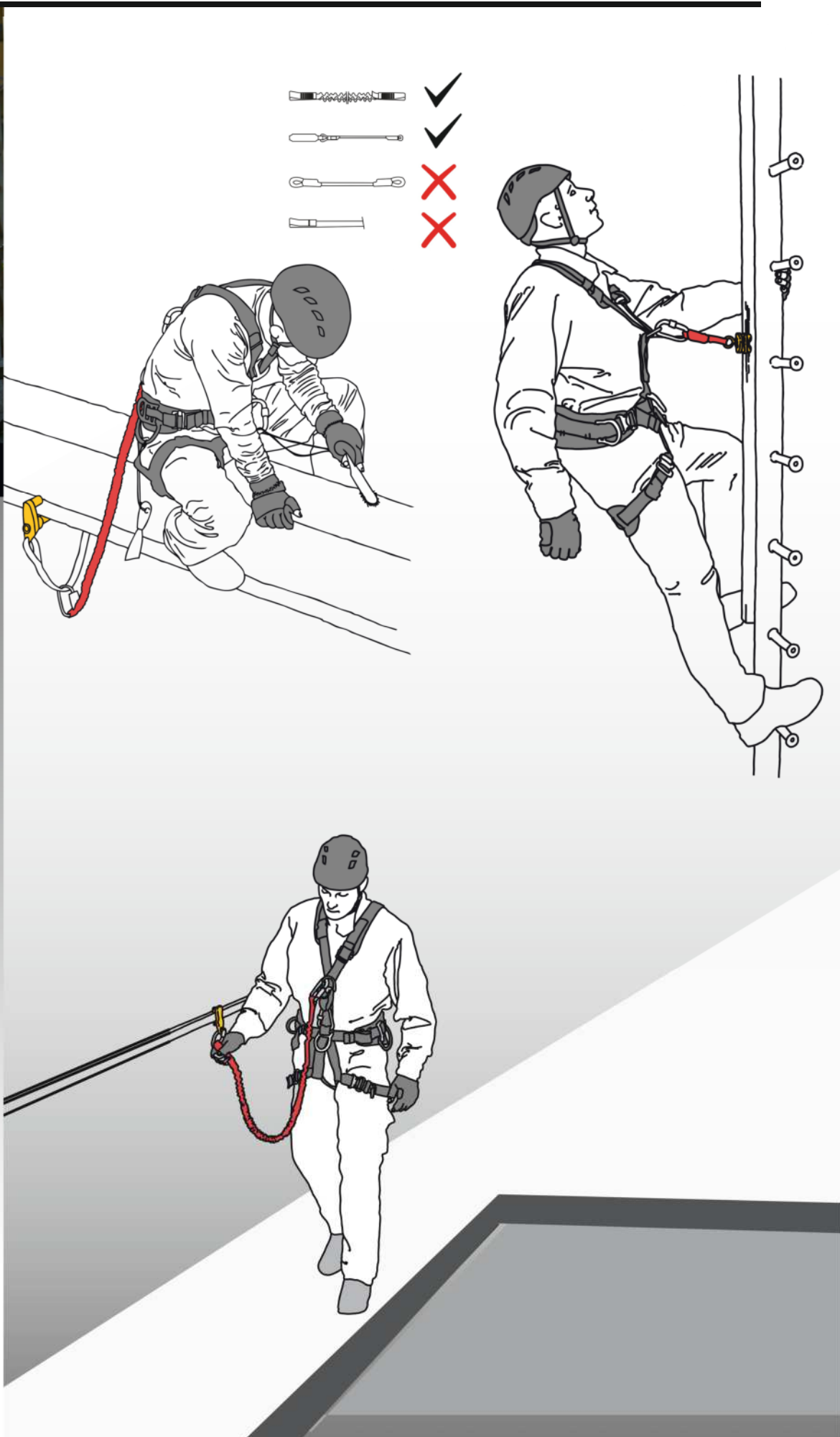

permanent lifelines

Permanent lifelines serve to secure workers in places where it is possible to set up fixed anchor point in the working place or near it. These are then interconnected by steel rope or a rail. For moving and securing, the worker uses connectors (EN 362) or special slider made for this purpose and supplied by the system manufacturer. The advantage of permanent lifelines is their long operating life and variability of use.

Fall arrest systems form an important element of the safety chain. When used correctly, they ensure sufficient absorption of fall energy, thus preventing the worker's body from being damaged. If the worker faints during or after fall, it is necessary to transport him to a safe place. The long hanging of unconscious body may have fatal consequences (trauma caused by hanging). Therefore keep in mind that fall arrest systems should be only used by trained workers. In case of need they should be able to aid each other at rescue and recovery action.



-  ✓
-  ✓
-  ✗
-  ✗

W9600
FLASH INDUSTRY
working helmet



W1010BB09
LOCKER
guided type fall
arrester



W4100Y120
JOULE
energy
absorber



K4241Z005
**OVAL STEEL
CONNECTOR**
triple lock



W0063BB
TECHNIC standard
fully adjustable
fall arrest and
positioning
harness



K0122EE07
OXY triplelock
light alloy oval
carabiner



W1012WB
SITE + K370
work positioning
lanyard



W0052B010
WORKING BAG
transport bag for
working harness



W4462X085
REACTOR 140
ROPES „Y“ 85 cm
shock absorber



X0075XX14
**BANTAM
BEAMER**



RK801EE00
PULLEY EXTRA
durable and
lightweight
pulley



W2016*080
SLING LANYARD
sewn sling





tree care

An arborist, arboriculturalist or tree surgeon is a professional in the practice of arboriculture, which is the management and maintenance of the trees. To move around freely and efficiently, arborists fasten a rope from the ground and then install a device for ascending the rope. Once the arborist is in position, he needs to remain balanced and feels comfortable for pruning, removal of dead branches, shaping of tree for structural, health and aesthetic purposes.

Arborist is an expert who looks after trees in public green areas with the intention to keep them healthy and in a state of operational safety. He proposes solutions for treatment based on arboristic knowledge while taking into account the interests of nature and environment conservation as well as regulations affecting work safety. This profession is inherently connected with moving in the tree using rope techniques, where the arborist installed an ascent rope from the ground by throwing a bag. In the tree he can then choose a suitable anchor point where he places a cambium protector and then places his working rope into it. After reaching the working place and before starting the actual work, the arborist must be in a comfortable and safe position. This is ensured by adjustable positioning devices.



Prior to starting work, the arborist in the tree must always have two independent adjustable positioning devices.



There are several methods of how to use rope techniques to get from the ground into a tree. One method is using a footlock.

One of the most effective options of getting into the tree is setting up ascent ropes from the ground. It is done by throwing a light bag carrying a thin rope over the required anchor point. The ascent system is then pulled by this light rope.

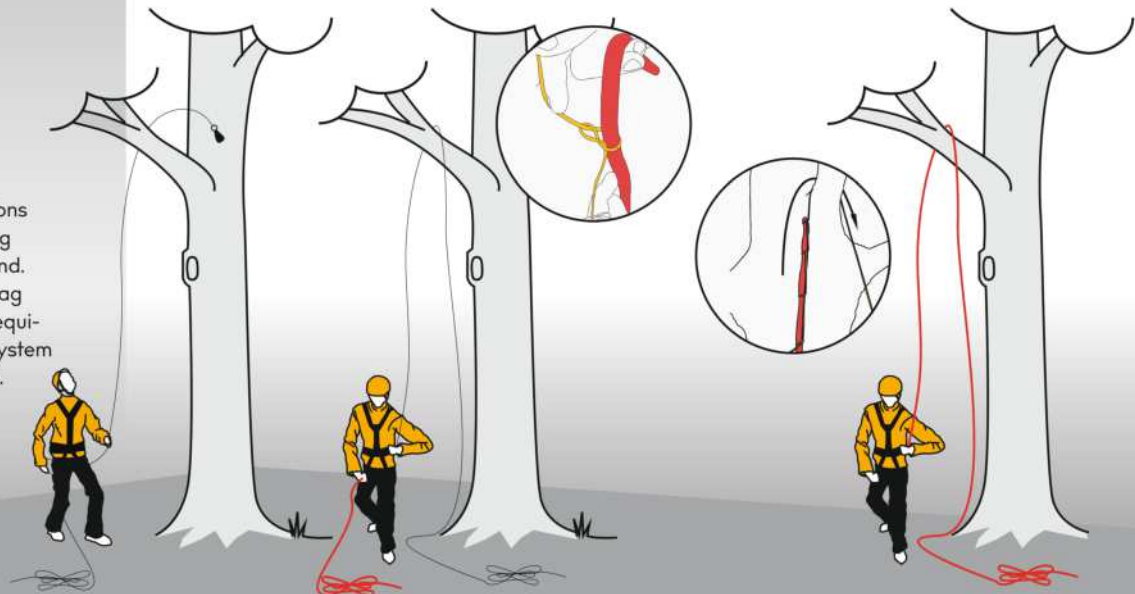

W9602QX00
FLASH AERO
working helmet



RK804BX0R
LIFT
hand ascender



L045000
STATIC R44 11.0
static rope



K0122EE07
OXY triplelock
light alloy oval carabiner



K0119EE00
BORA triplelock
light alloy HMS carabiner



W1040R
JINGLE II
cambium saver



W0061DR
TIMBER 3D
work positioning harness for arborists



K032SIR00
SIR
multipurpose device for rope access



W2001
OPEN SLING
sewn sling



W1028BY00
TOOL HOLDER



W9500Y
TREEMOUSE
arboristic throwing bag



W1024BX
FOOTER II
ascender webbing



W2608
TIMBER ACCESSORY CORD
with sewn eyes



C0001YY00
CARRY BAG
practical bag for a rope



RK800EE00
PULLEY SMALL
durable and light weight pulley



C0053RW
FIRS AID BAG
(without contents)





ropes courses and adventure parks

Complete range of the equipment intended for the rope courses and adventure parks. The safety equipment for each participant basically consists of a harness, a lanyard and a belay system. Sometimes helmets are also used.

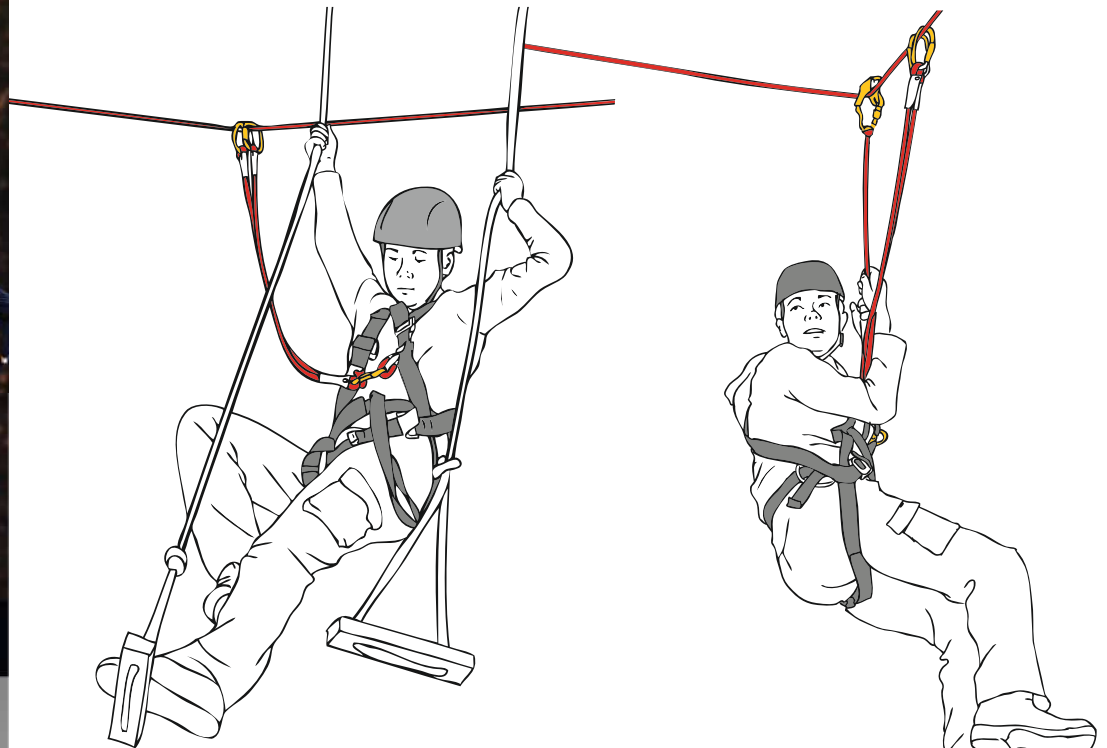

Rope parks are a combination of working and sports climbing. It is a leisure-time activity mainly carried out by people who are gaining experience with climbing. This activity combines working as well as sports equipment. The person (client) is ideally dressed in a whole-body harness. To connect to the steel security rope there are two connectors and these are connected to the harness by a fabric loop. In addition, the client is equipped with a double pulley, which is connected to the harness fabric loop.

Funicular (fly-over crossing). Here the client must first attach a double pulley to the steel rope on which he slides over the distance given. Behind the pulley, he attaches the first and the second security loop with the connector. The whole weight of client is in the pulley. Security loops move freely behind the pulley.

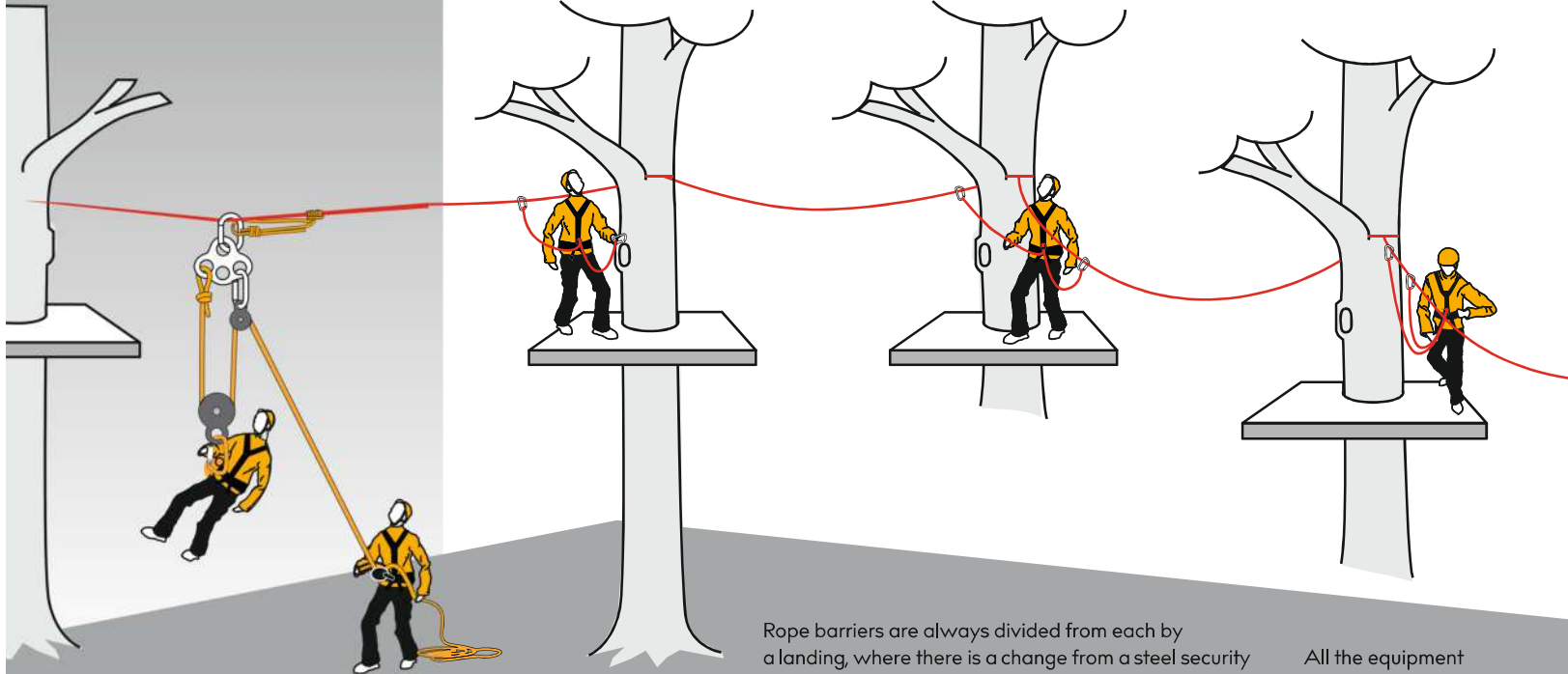

Rope barriers are always divided from each by a landing, where there is a change from a steel security rope to another (i.e. from one rope barrier to another). The client always has to lock one security loop and the other security loop. It must never happen that both loops are disconnected from the security steel rope at the same time. It is the same system as securing via ferrata.

All the equipment used in the rope park must be checked every 12 months even if it is sports equipment.

W9600
FLASH INDUSTRY
working helmet



K0122EE07
OXY triplelock
light alloy oval
carabiner



K82008Z
SMALL CONNECTOR
with automatic
locking



W2200W100
LANYARD „I“



W0068BR
BODY II standard
fall arrest harness



K82008Z
MAILLON SMALL OVAL
steel maillon
carabiner



RK803BB00
TANDEM PULLEY



C0012YB
FALCONER FULL

K4241Z007
OVAL STEEL CONNECTOR
triplelock



C0053RW
FIRS AID BAG
(without contents)

K9000BB03
PORTER
plastic holder



S9000YY35
GEAR BAG
waterproof bag

EVACUATION SET



K032SIR00
SIR
multipurpose device
for rope acces



RK713BB00
RIGGING PLATE
1/3



K4241Z005
OVAL STEEL CONNECTOR
srew



RK800EE00
PULLEY SMALL
durable and
lightweight
pulley



RK801EE00
PULLEY EXTRA
durable and
lightweight
pulley



K0122EE07
OXY triplelock
light alloy oval
carabiner



wind turbines

Work at height for wind turbine operators includes the elements of a safe system of work, equipment selection and inspection, use of tools, risk assessment, method statements and emergency procedures. Evacuation and rescue using industry standard equipment are practiced at height.

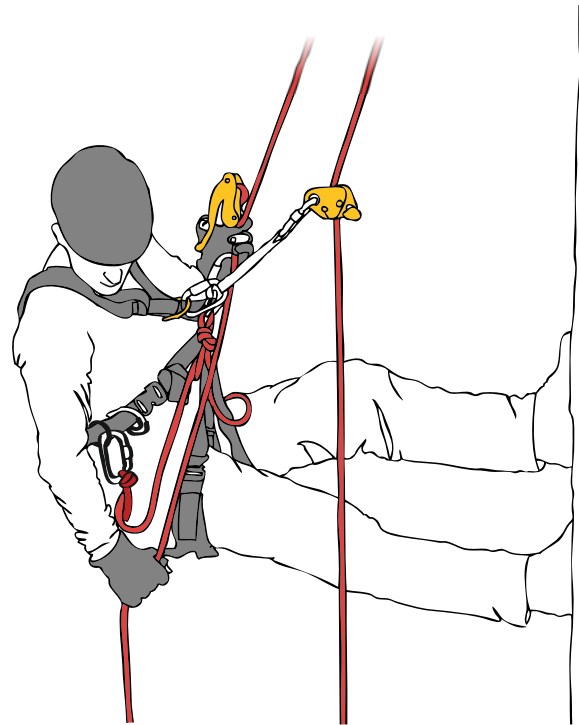

rope descend

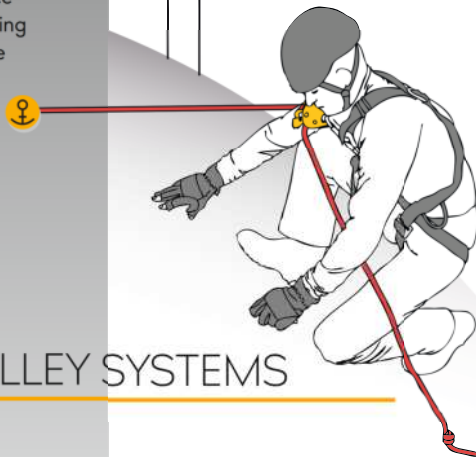

BASIC PULLEY SYSTEMS

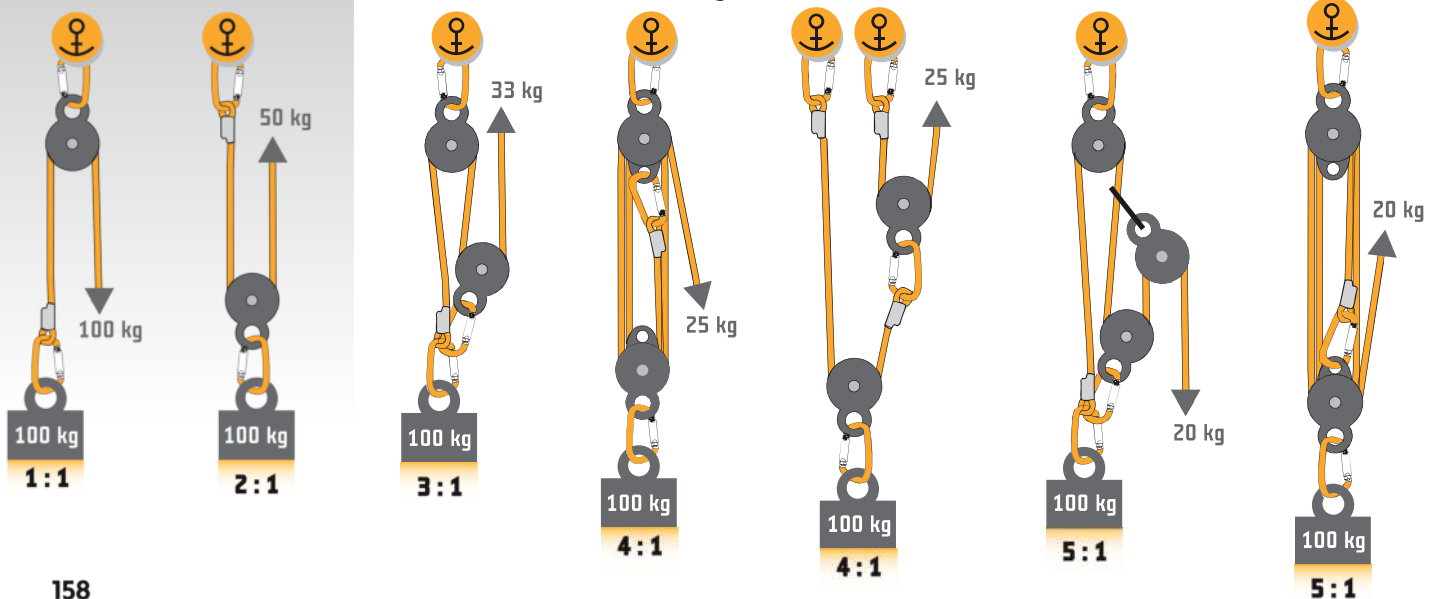

W9603QX
FLASH ACCESS
working helmet



RK804BX0R
LIFT
hand ascender



W1010BB09
LOCKER
guided type fall
arrester



K032SIR00
SIR
multipurpose device
for rope acces



L045000
STATIC
R44 11.0
150 m
static rope



L0450RR
STATIC
R44 11.0
150 m
static rope



W8100B
ROPE
PROTECTOR



W004*120
EYESLING
sewn sling



W0079DR
EXPERT 3D
speed
fully adjustable
rope access
harness



K6400BB
CAM CLEAN
chest ascender



K4080ZO
D STEEL
CONNECTOR
srew



K0119EE00
BORA
triplelock
light alloy
HMS carabiner



RK801EE00
PULLEY EXTRA
durable and
lightweight
pulley



RK800EE00
PULLEY SMALL
durable and
lightweight
pulley



W1024BX
FOOTER II
ascender webbing



W4462X085
REACTOR 140
ROPES „Y” 85 cm
shock absorber



W2300W150
LANYARD „I”



ACCESSORIES



K9000BB03
PORTER
accessory carabiner



W0010YB
FRANKLIN
work positioning seat



S9000YY50
WORKING BAG
transport bag



C0046BB
TARP DUFFLE
expedition bag



 **military
and special forces**

Complete range of black textile and metal (matt) products, including ropes and lanyards. Special ropes with unique features. Easy use of equipment in the cruelest conditions you can image. Handling in gloves, manipulation in a dark and quick releasing are obvious.

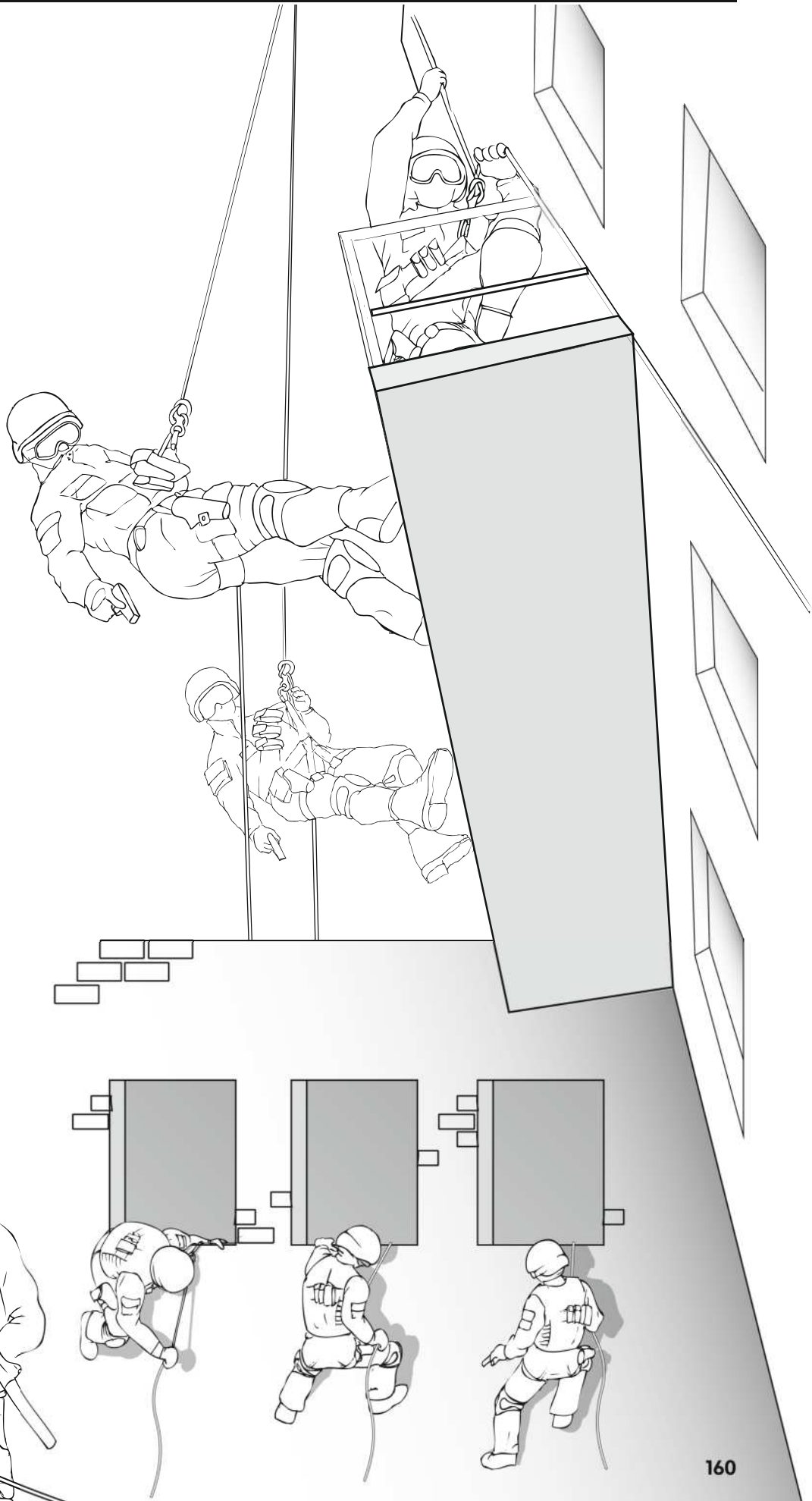

X0033
FLASH INDUSTRY
work helmet



K0122BB06
OXY twist lock
light alloy
carabiner



K6180BB
RESCUE FIGURE EIGHT
special figure eight
for rescue



K6132BB
BUDDY
belay tube



L0230BB
STATIC 10,5
static rope



W1010BB09
LOCKER
guided type fall
arrester



W0022BB
URBAN II
sit harness



W1015B020
LOCKER SLING
certified sling for the
Locker



W004*120
EYE SLING
sewn sling



W8100B
ROPE PROTECTOR



W9601BB
SIR
multipurpose device
for rope acces



RK804BX0R
LIFT
hand ascender



W0005BB09
LAIKA
dog harness



ACCESSORIES



K9000BB03
PORTER
accessory carabiner



S9000BB35
WORKING BAG
waterproof bag



W1001BB
URNA
leg rope bag



chair lift evacuation

Ski lift or gondola evacuations utilize specialized rescue techniques and gear that must perform regardless of weather conditions.

The success of evacuation operations begins with having the proper ski lift or gondola evacuation gear then hinges upon the instruction, training and practice of the operating personnel.

If the ski lift equipment fails, the person in charge must evacuate passengers according to the evacuation plan. Evacuation of a ski lift requires specific techniques for movement along a cable. For maximum efficiency, these operations are led simultaneously by several independent teams.

Evacuation is a team effort and requires perfect coordination by everyone involved. SINGING ROCK team cooperates with ski resorts all over Czech Republic to improve rescue methods and develop a new gear.

Rescue activities are unique in many ways when speaking about working at height and above depth. First of all it is an activity when people's lives are saved, therefore the rescuers must work fast, accurately and efficiently to keep themselves safe. That is why rescuers use the simplest methods possible. One of the activities is evacuation of persons from a funicular. Below is presented a complex system of funicular evacuation, prepared by Singing Rock in cooperation with the Czech Republic Mountain Rescue organization. Our experts will be happy to explain you everything necessary.

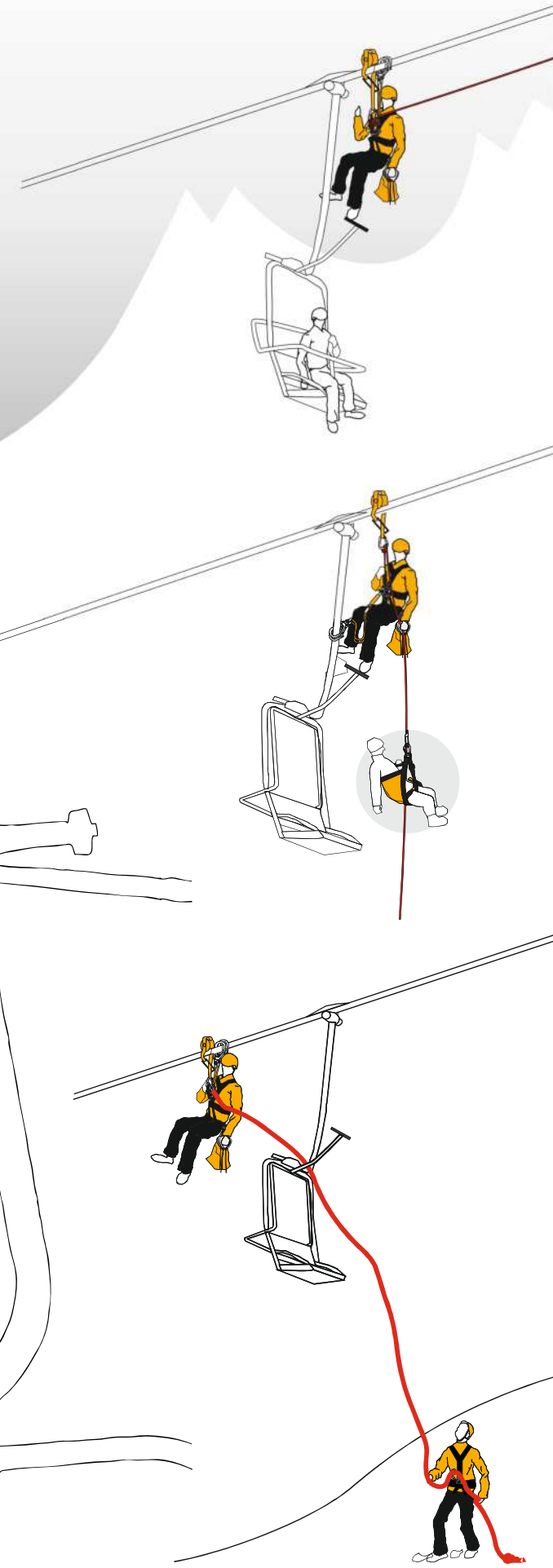
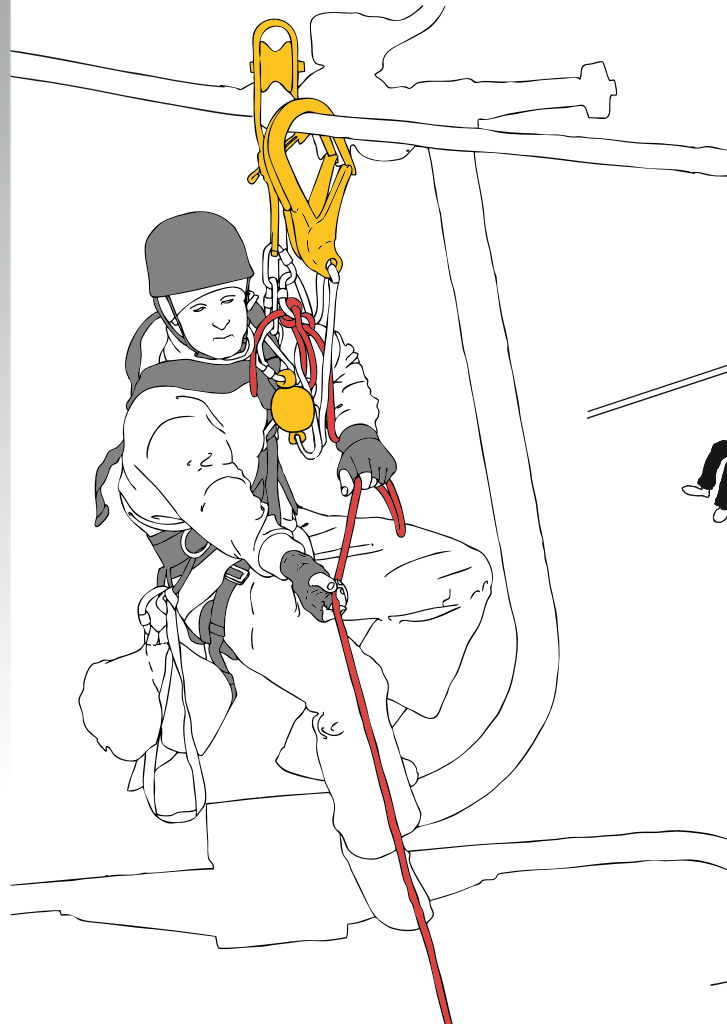

SAFETY FIRST

W9603RX00
FLASH ACCESS
working helmet



K0107EE00
BORA screw
light alloy
HMS carabiner



K424IZ005
OVAL STEEL CONNECTOR
screw



K355OPP
CONNECTOR GIGA



L0250RR
STATIC 11,0
static rope

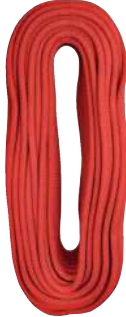

W0079DR
Expert 3D speed
fully adjustable rope
access harness



K6180ZO
RESCUE FIGURE EIGHT
special figure eight
for rescue



W4400WW00
REACTOR 140
shock absorber



K82310Z
MAILLON BIG D
steel maillon carabiner



W0003BY09
AXILLAR
rescue sling



K82008Z
MAILLON SMALL OVAL
steel maillon carabiner



W2001*060
OPEN SLING
sewn sling, 60 cm



K0004BB
EASY LIFT
rescue pulley



W8201BY00
EVACUATION TRIANGLE SIT II



S9000YY50
WORKING BAG
waterproof bag



BELAYER



W8201BY00
EVACUATION TRIANGLE SIT II



L0250RR
STATIC 11,0
static rope



W9600
FLASH INDUSTRY
working helmet



K424IZ005
OVAL STEEL CONNECTOR
screw



K0107EE00
BORA screw
light alloy
HMS carabiner



K6180ZO
RESCUE FIGURE EIGHT
special figure eight
for rescue

PRODUCT	PAGE	PRODUCT	PAGE	PRODUCT	PAGE
ACCESSORY CORD	48	D – MOBILE	84	GYM 10.1	44
ACCORD 8.3	45	D STEEL / SCREW	61	HAMMER CORD	48
ACCORD DRY 8.3	45	D STEEL / TRIPLE LOCK	61	HARNESS PADDING	23
ADJUST	102	DEFENDER	49	HECTOR / SCREW	54
ALADIN	27	DOUBLE STOP PLUS	76	HECTOR / TRIPLE LOCK	54
ANTISHOCK I	16	DRY BAG	115	HECTOR BC / SCREW	54
ATIKA ROPE PROTECTOR	48	DURAN 10.4	45	HECTOR BC / TRIPLE LOCK	54
AXILLAR	103	EASY LIFT	83	HERO 9.6	42
BABY RESCUE BAG	31	EDGE ROLLER	49	HERO DRY 9.6	42
BACK-UP	81	EDGE ROLLER – PART	49	HOODY	125
BAG	130	EVACUATION TRIANGLE COMBII	30	HOODY FULL ZIP	125
BANNERS	132	EVACUATION TRIANGLE SIT II	30	ICON 9.3	42
BANTAM BEAMER	85	EVAQ	96	ICON DRY 9.3	42
BASEBALL HAT	126	EVAQ BAG	97	IKAR AAS-1 CANTILEVER ARM	92
BASEBALL HAT LIGHT	126	EVAQ HUB	96	IKAR DB-A3 TRIPOD	95
BASIC	21	EVAQ ROPE	97	IKAR GROUND SLEEVE	92
BASIC LIGHT	21	EXPERT 3D / SPEED	8	IKAR H	90
BEACH FLAG	132	EXPERT 3D / SPEED STEEL	9	IKAR HRA	90
BEANIE	127	EXPERT 3D / STANDARD	9	IKAR HRA TRIPOD CONSOLE	95
BEANIE HAT	128	EXPERT III	10	IKAR HWB	89
BELT	128	EYE SLING 30 KN	100	IKAR HWS	90
BIG CONNECTOR	61	FALCONER 3/4	119	IKAR LOWER GROUND SLEEVE	93
BIG SQUARE	60	FALCONER FULL	119	IKAR LOWER GROUND SLEEVE CORE HOLE	93
BIG TWIST	60	FALCONER TACTICAL	119	IKAR MOBILE ATTICS BASE	94
BODY II ENERGY SPEED	19	FALL ARRESTER SET	110	IKAR MOBILE GROUND BASE	93
BODY II SPEED	18	FIGURE 8 L	79	IKAR PLW WINCH	95
BODY II STANDARD	18	FIGURE 8 M	79	IKAR WALL SLEEVE	92
BORA / SCREW, BORA / TWL	55	FINE LINE	102	IKAR WINCH CANTILEVER ARM CONSOLE	94
BORA / TRIPLE LOCK	55	FIRST AID BAG	117	IKAR WINCH TRIPOD CONSOLE	95
BORA GP / SCREW	55	FIRST AID BAG – LARGE	117	INDY EVO PLUS	77
BUDDY	78	FIXING MATERIAL FOR GROUND AND WALL SLEEVE	93	INOS 3.5	88
CAM CLEAN	80	FLASH	68	INOS 6N	88
CANTILEVER ARM CONSOLE	94	FLASH ACCESS	69	JACOB	104
CARRY BAG	115	FLASH AERO	69	JACOB DYNEEMA	104
CLASSIC ADAPTOR (PAIR)	72	FLASH INDUSTRY	69	JINGLE II	29
COLT / BENT	56	FLASH PADDING	72	JOULE	109
COLT / SCREW	56	FLAT WEBBING	105	KATA 9.7	43
COLT / STRAIGHT	56	FOOTER II	104	KATA DRY 9.7	43
CONDOM	131	FOOTER XP	105	KEY HOLDER	129
CONNECTION STRAP	23	FRANKLIN	27	LAIKA	30
CONNECTOR GIGA	61	GEAR BAG	114	LANYARD “I” 22 KN	101
CONTRA 10.5	41	GEMINI 79	46	LANYARD “V” 22 KN	101
COVER	73	GLUE IN ANCHOR	84	LARA	102
COW’S TAIL	47	GRIPPY	120	LIFT	80
CULTER	121	GRIPPY 3/4	120	LOCKER	81

PRODUCT	PAGE	PRODUCT	PAGE	PRODUCT	PAGE
LOCKER SLING	81	PULLEY TWIN	82	STATIC 11.0 / STATIC 10.5	40
MAILLON BIG D	60	RAMA	77	STATIC 9.0	41
MAILLON BIG DELTA	60	RAMA SET	77	STATIC R44 10.5	38
MAILLON MINI OVAL	60	REACTOR 140	107	STATIC R44 10.5	40
MAILLON SMALL DELTA	60	REDBLOCK	86	STATIC R44 11.0	38
MAILLON SMALL OVAL	60	RESCUE FIGURE EIGHT	79	STATIC R44 11.0	40
MINI D	62	RESCUE KNIFE	121	STEEL ANCHOR	103
MINI D SCREW	62	RESCUE POLE	118	STEEL LANYARD "I"	103
MINI PEAR	62	RIGGING PLATE 1/3	86	STORM 9.8	43
MONTY BAG	115	RIGGING PLATE 3/5	86	STORM DRY 9.8	43
MOVEMENT BAG	114	RL CHEST	27	STRAP FOR CAM CLEAN	80
MUG	129	ROOF MASTER	14	SUSPENSION TRAUMA SAFETY STRAP	23
MYSTIC 10.1	44	ROOFER SET	110	TANDEM PULLEY	82
MYSTIC DRY 10.1	44	ROPE BAG	116	TARP DUFFLE	114
NOTEPAD A5	131	ROPE PROTECTOR	49	TARZAN	16
OPEN SLING 22 KN	100	ROPEDANCER II	17	TARZAN ECONOMIC	17
OVAL STEEL / SCREW	61	ROPEMARKER	47	TECH INFO EN	133
OVAL STEEL / TRIPLE LOCK	61	SAFE 2 FLEX CARRIER	72	TECHNIC SPEED STEEL	13
OVERALL	122	SAFE NYLON MESH VISOR	72	TECHNIC STANDARD	13
OXY / SCREW, OXY / TWL	57	SAFE PC ELECTRIC ARC VISOR	72	TEXTILE BADGE	130
OXY / TRIPLE LOCK	57	SCAFOLDER SET	111	THERMOCUTTER	47
OXY BC / SCREW, OXY BC / TWL	57	SCARF	127	THROW LINE	48
OXY BC / TRIPLE LOCK	57	SCORE 10.1	44	TIMBER 3D	28
OZONE / SCREW	59	SEAMASTER 3D STAINLESS STEEL	15	TIMBER ACCESSORY CORD	29
OZONE / TRIPLE LOCK	59	SECURE EARMUFFS	73	TIMBER BRIDGE	29
OZONE / TWL	59	SHUTTLE	78	TOOL BAG	116
PALM CONNECTOR	61	SINGING ROCK PEN	131	TOOL HOLDER	105
PATRON 11.0	45	SINGING ROCK STICKERS	132	TRACK PLUS	102
PENTA	70	SIR	76	TREEMOUSE	29
PILOT	85	SIT WORKER 3D / SPEED	24	T-SHIRT BLUE CRACK	124
PITCHER	129	SIT WORKER 3D / SPEED STEEL	25	T-SHIRTS BACKBONE	123
POLE II	22	SIT WORKER 3D / STANDARD	24	TUBULAR WEBBING	105
POLO T-SHIRT	124	SITE	87	TWISTER	86
PORTER	62	SITE LANYARD	87	URBAN II	25
POSTERS	133	SLING LANYARD 22 KN	100	URNA	116
POUCH	117	SMALL CONNECTOR	60	USB FLASH DRIVE	129
PPE INSPECTION SET	111	SNAKE BRACE	85	VACUUM PACKING	97
PROFI WORKER 3D / SPEED	11	SNAP BACK HAT	126	WORK KNIFE	121
PROFI WORKER 3D / STANDARD	12	SPEED BELT	128	WORKING BAG	116
PROFI WORKER III	12	SPELEO	41	WORKING PANTS	122
PROTECTIVE CASE	97	SPELEO 10.5	41	WRISTBAND	130
PULLER	81	SPELEO R44 10.5	41	ZINC PLATED HANGER PLATE / WITH BOLT	84
PULLEY EXTRA	82	STAINLESS HANGER PLATE / WITH BOLT	84		
PULLEY MIKY	83	STATIC 10.5	39		
PULLEY SMALL	83	STATIC 11.0	39		

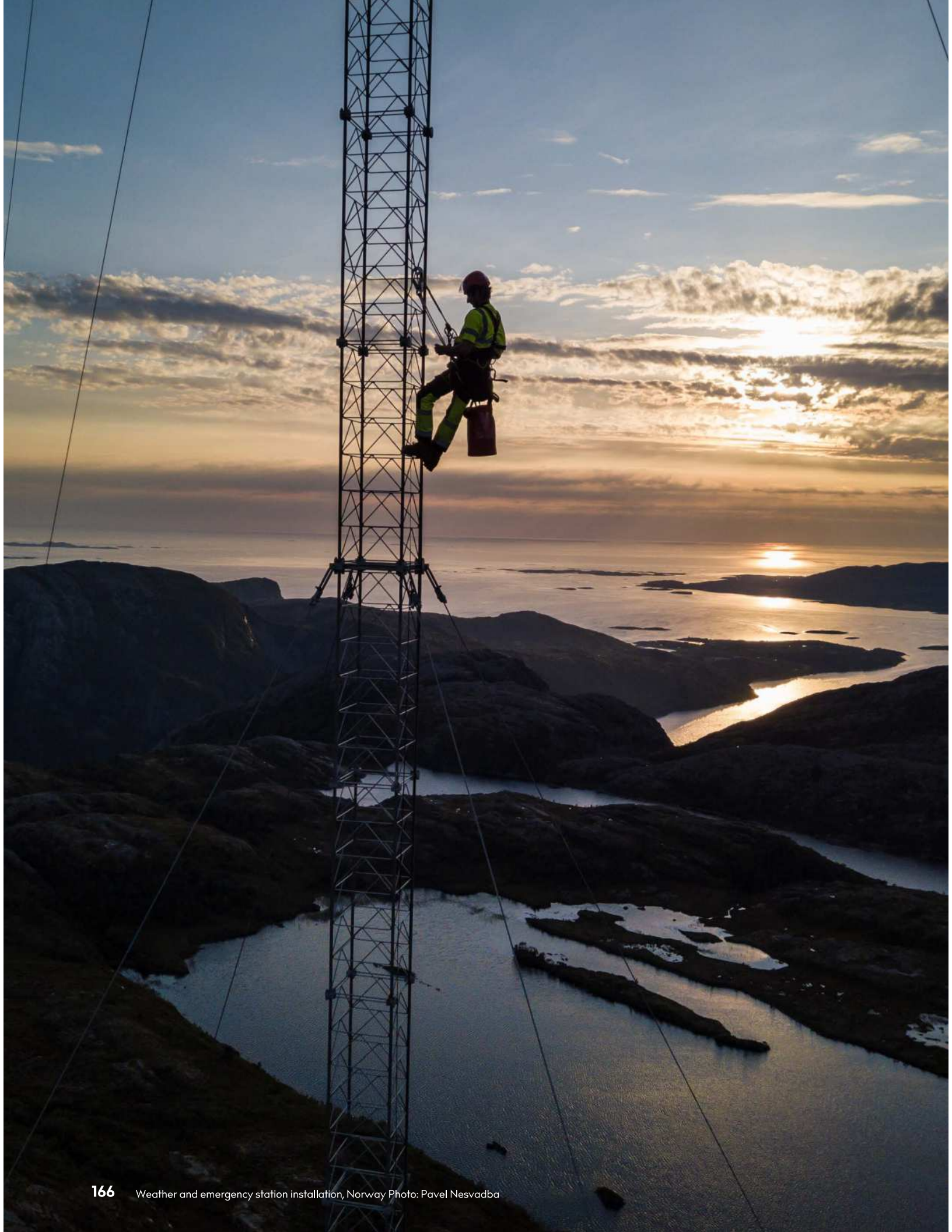

PRODUCT	PAGE	PRODUCT	PAGE	PRODUCT	PAGE
A0002SS01	84	C0081AX00	127	K012IEE00	54
A0031BS	121	C0081RX00	127	K0122BB05	57
A0030Y	121	C1013BB	123	K0122BB06	57
A0050HH00	121	C1014BB	123	K0122BB07	57
A4000S060	90	C1018BY	125	K0122EE05	57
A4000S090	90	C1019BY	125	K0122EE06	57
A4000SI20	90	C1020BY	125	K0122EE07	57
A4000S240	90	C1026AX	124	K0123BC05	57
A4000W018	89	C1027AX	124	K0123BC06	57
A4000W028	89	C2150BY	104	K0123BC07	57
A4000W035	89	C2151BY00	104	K0123EC05	57
A4002BS33	90	C5056	27	K0123EC06	57
A4002BS42	90	C9091XX	128	K0123EC07	57
A4004BS12	90	C9092BX	128	K0124ST09	61
A4004BS18	90	C9092XX	128	K0124SY09	61
A4004BS33	90	E0015XX	47	K031DSD00	76
A4064XX30	95	K0004BB	83	K032SIR00	76
C0001BB	116	K0006RP00	86	K04000BB	81
C0001YY00	115	K0016AA00	59	K3536BB00	61
C0006BH	120	K0016BB00	59	K3536PP00	61
C0006HH	120	K0017AA00	59	K3550BB00	61
C0012YB	119	K0017BB00	59	K3550PP00	61
C0013YB	119	K0018AA00	59	K3690ZO	60
C0014YB	119	K0018BB00	59	K3702PP	60
C0035AO12	105	K0027BY00	62	K4080ZO	61
C0037BB12	105	K0030OG00	86	K4081ZO	61
C0037RR12	105	K0043OX00	77	K4241ZO05	61
C0046BI20	114	K0043SX00	77	K4241ZO07	61
C0046BB70	114	K0050OS01	49	K5052EE00	62
C0046BB90	114	K0050OS03	49	K5182EE00	62
C0051BH	126	K0101BX00	77	K6021BB	79
C0051HH	126	K0107BB00	55	K6021EE	79
C0053AX	127	K0107BP00	55	K6031BB	79
C0053OX	127	K0107EE00	55	K6031EE	79
C0053RW	117	K0107EP00	55	K6132BB	78
C0053RX	127	K0108BB00	55	K6132EE	78
C0054BX	127	K0108EE00	55	K6140BB00	78
C0055BX	127	K0110BB00	56	K6140EE00	78
C0058RR00	117	K0110EE00	56	K6180BB	79
C0067BS00	128	K0111BB00	56	K6180ZO	79
C0069BG00	128	K0111EE00	56	K82006Z	60
C0069PB00	128	K0112BB00	56	K82008Z	60
C0070SL00	126	K0112EE00	56	K82207Z	60
C0071AA00	70	K0114BB00	54	K82210Z	60
C0071RR00	70	K0114BC00	54	K82310Z	60
C0071SS00	70	K0114EC00	54	K82410Z	60
C0071WW00	70	K0114EE00	54	K82508Z	60
C0072BB00	117	K0119BB00	55	K9000BB03	62
C0073BY00	114	K0119EE00	55	L0002	48
C0074BY00	126	K0121BB00	54	L0003	48
C0079BX00	127	K0121BC00	54	L0041 – L0081	48
C0080BX00	127	K0121EC00	54	L0220BB	41

L0220WR	41	P0020	132	S9000YY35	114
L0230BB	39	P0020BB02	132	S9000YY50	114
L0230BB	40	P0020BB03	132	S900IBX60	115
L0230KK	39	P0020BB04	132	S900IYX40	115
L0230KK	40	P0020BB05	132	W0003BY09	103
L0230RR	39	P0021	132	W0005BB09	30
L0230WR	39	P0021BB00	132	W0005YBO9	30
L0240WR	41	P0021BB03	132	W0008BS	116
L0250BB	39	P0021BB04	132	W0010BB	27
L0250BB	40	P0021BB05	132	W0010YB	27
L0250RR	39	P0022XX00	131	W0022BB	25
L0250WR	39	P0023XX00	131	W0050	16
L026	41	P0024XX00	130	W0052B010	116
L0340AX	45	P0025XX00	132	W0052B012	116
L0360GG	44	P0026XX00	130	W0059BR	17
L0380YX	42	P0027WX00	133	W0061DR	28
L0384RX	42	P0028WE00	133	W0063BB	13
L0430BB	38	P0030XX00	131	W0064BB	13
L0430BB	40	P0031XX01	130	W0068BB	18
L0430KK	38	P0031XX02	130	W0068BR	18
L0430KK	40	P99100X	129	W0070RR00	29
L0430RR	38	RK702XX10	84	W0071BB	18
L0430WR	38	RK702XX12	84	W0071BY	18
L0440WR	41	RK703XX10	84	W0073	22
L0450BB	38	RK704XX10	84	W0074DR	15
L0450BB	40	RK704XX12	84	W0075DB	24
L0450OO	38	RK713BB00	86	W0075DR	24
L0450RR	38	RK714BB00	86	W0076DB	24
L0450WG	38	RK715XX10	84	W0076DR	24
L0510	45	RK715XX12	84	W0077DR	25
L0514	45	RK716XX10	84	W0078BB	10
L0520GW	42	RK716XX12	84	W0078BR	10
L0524GW	42	RK800BB00	83	W0078DB	9
L0530RA	44	RK800EE00	83	W0078DR	9
L0534AG	44	RK801BB00	82	W0079BB	10
L0540C450	47	RK801EE00	82	W0079BR	10
L0540YX	45	RK802BB00	82	W0079DB	8
L057AA	43	RK802EE00	82	W0079DR	8
L0580AA	43	RK803BB00	82	W0080BR	10
L3020	46	RK804BX0L	80	W0080DR	9
L3040GA00	43	RK804BX0R	80	W0081BR	12
L3044AG00	43	RK805BX00	80	W0081DB	12
L3050RY00	44	RK806BB00	83	W0081DR	12
L903IYX10	48	RK850X100	103	W0082BR	12
M000XSET	111	RK850X130	103	W0082DB	11
M0020X1	110	RK850X180	103	W0082DR	11
M0020X2	110	RK851XX03	103	W0085BB00	80
M0021XX	111	RK851XX05	103	W0086B0	16
M0022XX	110	RK900PP00	48	W0087BY	17
M0201XX00	77	S1100BY	81	W0089SY	21
P0010X030	129	S9000BB35	114	W0090SY	21
P0010X050	129	S9000BB50	114	W0091BY	14
P0012BB00	129	S9000RR35	114	W0092BB	23
P0019XX00	129	S9000RR50	114	W0093SY	19

W0200BB	27	W2100X080	102	W4462X155	108
W1001WW10	102	W2100X120	102	W4463X085	108
W1001WW15	102	W2100X150	102	W4463X155	108
W1001WW20	102	W2200W001	101	W4470Y100	108
W1002WO20	102	W2200W002	101	W4471Y100	108
W1002WS10	102	W2200W100	101	W4472Y100	108
W1002WY15	102	W2300W060	101	W8000BX00	118
W1010BB09	81	W2300W080	101	W8100B	49
W1011WB02	87	W2300W120	101	W8201BY00	30
W1011WB04	87	W2300W150	101	W8211BY00	30
W1012WB02	87	W2301*060	101	W8220	31
W1012WB04	87	W2301*080	101	W9002XX17	97
W1015B020	81	W2301*120	101	W9002XX46	97
W1023	115	W2301*150	101	W9003RX45	97
W1024BX	104	W2303*060	101	W9500Y	29
W1025BX	104	W2303*080	101	W9601BB00	69
W1026BB	116	W2303*120	101	W9601QX00	69
W1027B	49	W2303*150	101	W9601RX00	69
W1028BY00	105	W2608	29	W9601WX00	69
W1029BX00	23	W2610	29	W9601YX00	69
W1036W130	102	W4100Y070	109	W9602QX00	69
W1040R	29	W4100Y120	109	W9602RX00	69
W1041R	29	W4100Y160	109	W9603QX00	69
W1042R	29	W4400WW00	107	W9603RX00	69
W1047Y100	102	W4410W085	108	W9604XX00	72
W1051BX	105	W4410W155	108	W9605XX00	73
W1501XX03	88	W4411W085	108	W9801BY	122
W1502XX06	88	W4411W155	108	W9802BY	124
W1510X000	96	W4412W085	108	W9803BY	122
W1511X000	96	W4412W155	108	X0004GB	47
W1512X	97	W4413W085	108	X0048XX25	73
W1513XX00	97	W4413W155	108	X0048XX29	73
W2001*060	100	W4420W085	108	X0048XX31	73
W2001*080	100	W4420W155	108	X0049XX00	72
W2001*120	100	W4421W085	108	X0051XX00	72
W2001*150	100	W4421W155	108	X0052XX00	72
W2004*060	100	W4422W085	108	X0053XX00	72
W2004*080	100	W4422W155	108	X0070XX34	85
W2004*120	100	W4423W085	108	X0075XX14	85
W2004*150	100	W4423W155	108	X4002XX00	95
W2016*060	100	W4430W155	108	X4003XX00	95
W2016*080	100	W4433W155	108	X4005XX00	92
W2016*120	100	W4440W155	108	X4006XX00	92
W2016*150	100	W4441W155	108	X4007XX00	92
W2018A060	85	W4442W155	108	X4008XX00	93
W2018B120	85	W4450X085	108	X4009XX00	93
W2018R090	85	W4450X155	108	X4010XX00	93
W2018Y030	85	W4452X085	108	X4011XX00	93
W2019A060	85	W4452X155	108	X4012XX00	94
W2019B120	85	W4453X085	108	X4013XX00	94
W2019R090	85	W4453X155	108	X4014XX00	94
W2019Y030	85	W4460X085	108	X4015XX00	94
W2020X080	23	W4460X155	108		
W2100X060	102	W4462X085	108		



Rock&Lock

Patented smart buckle used on SINGING ROCK harnesses and other products enables to lock and open very quickly.



Lady fit

Specially designed products for women.



Route 44

SINGING ROCK patented technology for rope production. A rope is produced on 44 carrier machine which provides great handling, low weight and durability.



Teflon®

Ropes protected with a DuPont™ TEFLON® fabric protector have extraordinary water and abrasion resistance.



Single Tech

With the Single Tech system each strand is braided into the sheath separately. Single Tech sheath construction increases the rope's wear resistance and improves the rope's mechanical properties, such as flexibility.



Single rope

Marking of single dynamic rope for climbing and mountaineering used in single strand.



Half rope

Marking of half rope for mountaineering, multipitch and ice climbing. Individual strands of rope are used in alternation in the protection system. This system reduces the risk of rope breakage caused by falling stones, and provides maximum safety in alpine conditions and for difficult climbs.



Twin rope

Marking of twin ropes for mountaineering, multipitch and ice climbing. Pairs of the same type of rope are always used, sharing the same protection points. Twin ropes guarantee a high level of safety, especially for multipitch climbing in alpine conditions.



Stitched eye

sewn loop at the end of kernmantle low stretch rope used as a substitute of a knot. Used mainly to attach ropes to anchor or attachment points.



UIAA

Products marked with this symbol meet strict UIAA safety requirements. The UIAA is the International Mountaineering and Climbing Federation. In most cases, UIAA requirements are sometimes stricter than EN standards.



Symbol of compliance

The CE symbol declares that the product is in compliance with the safety requirements of the applicable European standard. The number after the symbol CE (e.g. CE 1019) identifies the relevant accredited testing lab.



UIAA Water repellent

A standard for water repellent ropes approved by the UIAA Safety Commission. To pass the test at a certified laboratory, the amount of absorbed water must not be greater than 5% of the rope's weight. For comparison, a non-treated rope absorbs around 50% of water in this test, and ropes labelled as „dry“ but lacking adequate treatments can absorb between 20% and 40% of water.



ANSI

American National Standards Institute – is a private non-profit organization that oversees the development of voluntary consensus standards for products, services, processes, systems, and personnel in the United States.[3] The organization also coordinates U. S. standards with international standards so that American products can be used worldwide.



NFPA

The National Fire Protection Association is a United States trade association, albeit with some international members, that creates and maintains private, copyrighted standards and codes for usage and adoption by local governments.



Paper Trail

Symbol means, that the products are supplemented with a scannable Data Matrix code and all information like serial number, production date, photo, description, instructions etc. are uploaded to a cloud based PaperTrail, an all-in-one system for equipment management and maintenance records. For more information visit: www.singingrock.com/papertrail



Inter Core

The unique patented technology providing maximum safety even in case of a damaged sheath. The rope is made from 4 layers of parallel core filaments, braided core, braided intermediate sheath made from staple fibres and single tech sheath.

ABS	Acrylonitrile butadiene styrene is a common thermoplastic polymer. The most important mechanical properties of ABS are impact resistance and toughness. ABS is stronger than pure polystyrene.
Acryl	Lightweight, soft, and warm, with a wool-like feel fabrics or yarn. Strong and warm, acrylic fiber is often used for sweaters and tracksuits and as linings for boots and gloves, as well as in furnishing fabrics and carpets. It is manufactured as a filament, then cut into short staple lengths similar to wool hairs, and spun into yarn.
Anodizing	Electrolytic passivation process used to increase the thickness of the natural oxide layer on the surface of metal parts. Anodizing increases resistance to corrosion and wear, and provides better adhesion for paint primers and glues than bare metal does.
Bamboo	Cloth, yarn, and clothing made out of bamboo fibres. Bamboo fabric is exceptionally soft and light. It is also incredibly hydrophilic, absorbing more water than other conventional fibres such as cotton and polyester.
Cold forging	Deformation of metal while it is below its recrystallization point. This process is usually less expensive than hot forging and the end product requires little, if any, finishing work. Residual stress of material may occur as it handles high stress and high die loads
Cordura	Brand name for a collection of fabrics used in a wide array of products including luggage, backpacks, trousers, military wear and performance apparel. Cordura fabrics are known for their durability and resistance to abrasions, tears and scuffs. Cordura fabrics are usually made of nylon.
Cortex	Polyamide elastic woven fabrics. Cortex fabrics are designed to ensure the maximum ergonomics and comfort.
Dyneema	Registered trademark for a synthetic fabric that is stronger than Kevlar®. Dyneema® is composed of ultra high molecular weight polyethylene. It is resistant to water, most chemicals, UV radiation and bacterial.
ED coating	Electrophoretic deposition coating. A characteristic feature of this process is that colloidal particles suspended in a liquid medium migrate under the influence of an electric field (electrophoresis) and are deposited onto an electrode.
Elastane (Spandex)	Synthetic polyether-polyurea copolymer known for its exceptional elasticity. It is stronger and more durable than natural rubber.
EPS	Expanded polystyrene is a rigid and tough, closed-cell foam. It is made of pre-expanded polystyrene beads. Due to its technical properties such as low weight, rigidity, and formability, EPS can be used in a wide range of different applications.
Fiber glass	Type of fiber-reinforced plastic where the reinforcement fiber is specifically glass fiber. The glass fiber may be randomly arranged, flattened into a sheet (called a chopped strand mat), or woven into a fabric. Fiberglass is unique in its strength and yet it is lightweight. Although it is not as strong and stiff as composites based on carbon fiber, it is less brittle, and its raw materials are much cheaper.
Fleece	Soft napped insulating fabric made from a type of polyester called polyethylene terephthalate (PET) or other synthetic fibers. A lightweight, warm, soft and hydrophobic fabric. Regular polar fleece is not wind-proof and does not absorb moisture. It is readily generates static electricity.
G10 fiber	High-pressure fiberglass laminate, a kind of composite material. It is created by stacking multiple layers of glass cloth, soaking in epoxy resin, and compressing the resulting material under heat until the epoxy cures. G10 is favoured for its high strength, low moisture absorption, excellent electrical insulating properties and chemical resistance.
HF welding	Joining of materials by supplying High Frequency energy in the form of an electromagnetic field (27.12 MHz) and pressure to the material surfaces to be joined.
Hot forging	Deformation of metal while it is above the recrystallization point. Hot forging is recommended for the deformation of metal that features a high formability ratio. Hot forging provides a homogenized grain structure
Injection	Manufacturing process for producing parts by injecting material into a mould. Material for the part is fed into a heated barrel, mixed, and forced into a mould cavity, where it cools and hardens to the configuration of the cavity.
Kernmantle rope	Rope constructed with its interior core protected by a woven exterior sheath designed to optimize strength, durability, and flexibility. The core fibers provide the tensile strength of the rope, while the sheath protects the core from abrasion during use.
Kevlar	Kevlar is the registered trademark for a para-aramid synthetic fiber. Kevlar has many applications, ranging from bicycle tires and racing sails to body armor, because of its high tensile strength-to-weight ratio; by this measure it is 5 times stronger than steel. It is designed to protect users from cuts, abrasions and heat. Kevlar-based protective gear is often considerably lighter and thinner than equivalent gear made of more traditional materials.
Nylon	Generic designation for a family of synthetic polymers, based on aliphatic or semi-aromatic polyamides. Nylon is a thermoplastic silky material that can be melt-processed into fibers, films or shapes. Nylon is very much suitable for hosiery and the knitted fabrics because of its smoothness, light weight and high strength.
Polyamide (PA, PAD)	Macromolecule with repeating units linked by amide bonds. Synthetic polyamides are commonly used in textiles, automotive applications, carpets and sportswear due to their high durability and strength. Fibres are very tear-proof and abrasion-resistant and absorb little moisture (thus good transport of moisture away from the body) and are stretchy, crease-free, but also prone to pilling. Polyamide has the highest resistance of all textile raw materials (also when wet) and is very stretchy.
Polycarbonate	Group of thermoplastic polymers containing carbonate groups in their chemical structures. Polycarbonates used in engineering are strong, tough materials, and some grades are optically transparent.
Polyester (PES)	Category of polymers that contain the ester functional group in their main chain. Fabrics woven or knitted from polyester thread or yarn are used extensively in apparel and home furnishings. Industrial polyester fibers, yarns and ropes are used in car tire reinforcements, fabrics for conveyor belts, safety belts, coated fabrics and plastic reinforcements with high-energy absorption. Polyester has excellent return conduct thanks to the rippling property and is very light. Polyester also retains its shape and is colourfast, as well as resistant to sweat and UV-rays (lightfast). Polyester has a high melting point and transfers can therefore be printed on this material)
Polyethylene (PE)	Most common plastic, which is usually a mixture of similar polymers of ethylene. Polyethylene is of low strength, hardness and rigidity, but has a high ductility and impact strength as well as low friction. It shows strong creep under persistent force, which can be reduced by addition of short fibers. Its primary use is in packaging (plastic bags, plastic films, geomembranes, containers including bottles, etc.)
POLYMAR	Registered trademark for a polyester coated with polyurethane tarpaulin fabric. It is UV and weatherproof resistant.
Polypropylene (PP)	Thermoplastic polymer used in a wide variety of applications including packaging and labeling, textiles (e.g. ropes, thermal underwear and carpets), stationery, plastic parts and reusable containers of various types, laboratory equipment, loudspeakers, automotive components and polymer banknotes. An addition polymer made from the monomer propylene, it is rugged and unusually resistant to many chemical solvents, bases and acids. Polypropylene is the world's second-most widely produced synthetic plastic, after polyethylene.
Polystyrene	Synthetic aromatic polymer made from the monomer styrene. Polystyrene can be solid or foamed. General-purpose polystyrene is clear, hard, and rather brittle. Polystyrene is one of the most widely used plastics. Uses include protective packaging (such as packing peanuts and CD and DVD cases), containers (such as "clamshells"), lids, bottles, trays, tumblers, and disposable cutlery.
Polyvinyl chloride (PVC)	World's third-most widely produced synthetic plastic polymer, after polyethylene and polypropylene. PVC comes in two basic forms: rigid and flexible. The rigid form of PVC is used in construction for pipe and in profile applications such as doors and windows. It is also used for bottles, other non-food packaging, and cards (such as bank or membership cards). In flexible form, it is used in plumbing, electrical cable insulation, imitation leather, signage, phonograph records, inflatable products, and many applications where it replaces rubber.
Polyurethane (PU)	Polymer composed of organic units joined by carbamate (urethane) links. While most polyurethanes are thermosetting polymers that do not melt when heated, thermoplastic polyurethanes are also available.
Ripstop	Woven fabrics, using a special reinforcing technique that makes them resistant to tearing and ripping. During weaving, (thick) reinforcement threads are interwoven at regular intervals in a crosshatch pattern. Advantages of ripstop are the favourable strength-to-weight ratio and that small tears can not easily spread.
Stainless Steel	Steel alloy with a minimum of 10.5% chromium content by mass. Stainless steel is notable for its corrosion resistance. Stainless steel does not readily corrode, rust or stain with water as ordinary steel does. However, it is not fully stain-proof in low-oxygen, high-salinity, or poor air-circulation environments.
Teflon	Registered trademark for a synthetic fluoropolymer of tetrafluoroethylene. It is famous for its hydrophobic and abrasive protection properties.
Technora	Registered trademark for an aramid that is useful for a variety of applications that require high strength or chemical resistance. It is closely related to Kevlar (see Kevlar).
Thermolite	Synthetic material made by Invista and used as an insulator. The performance fibers are engineered with a differentiated fiber shape, able to produce battings with sought-after lightweight warmth.
Thermotransfer	Digital printing process in which material is applied to paper (or some other material) by melting a coating of ribbon so that it stays glued to the material on which the print is applied.
Ultrasonic finishing	Sound waves with frequencies higher than the upper audible limit of human hearing is joining the load-bearing core and the protective sheath into a compact unit. It is used to finish kernmantle ropes ends.
Velcro	Registered trademark for a hook-and-loop fastener, which consists of two components: typically, two lineal fabric strips (or, alternatively, round "dots" or squares) which are attached (sewn or otherwise adhered) to the opposing surfaces to be fastened.
Zinc plating	Prevents oxidation of the protected metal by forming a barrier and by acting as a sacrificial anode if this barrier is damaged.

STANDARDS

The list of EN and US standards for personal protective equipment (PPE) against falls from a height



EN 341
PPE against falls from height. Descender devices for rescue.



EN 566
Mountaineering equipment – Slings



EN 12275
Mountaineering equipment – Connectors



EN 353-1, 2
PPE against falls from a height. Guided type fall arresters.



EN 567
Mountaineering equipment. Rope clamps.



EN 12277
Mountaineering equipment – Harnesses



EN 354
PPE against falls from a height. Connecting equipment max. length 2 m (incl. connectors).



EN 795, EN 795 /A1
PPE against falls from a height. Anchor devices.



EN 12278
Mountaineering equipment. Pulleys.



EN 355
PPE against falls from a height. Energy absorbers.



EN 813
PPE against falls from a height. Sit harnesses.



EN 12492
Mountaineering equipment – Helmets for mountaineers



EN 358
PPE for work positioning and prevention of falls from a height. Work positioning systems.



EN 892
Mountaineering equipment. Dynamic (stretch) ropes.



EN 12841
PPE against falls from a height. Descender device for rope access system and rope adjustment devices.



EN 360
PPE against falls from a height. Retractable type fall arresters.



EN 959
Mountaineering equipment – Rock anchors



EN 15151
Mountaineering equipment – Braking devices



EN 361
PPE against falls from a height. Full body harnesses.



EN 1496
Rescue equipment. Rescue lifting devices.



ANSI Z359.1
Safety Requirements for Personal Fall Arrest Systems, Subsystems and Components



EN 362
PPE against falls from a height. Connectors.



EN 1497
Rescue equipment. Rescue harnesses.



CEN/TS 16415
Recommendations for anchor devices for use by more than one person simultaneously



EN 388
Protection gloves against mechanical risks



EN 1498
Personal fall protection equipment – Rescue loops



NFPA Class II
defined by NFPA 1983 as being designed to fit around the waist and thighs or under the buttocks and may be utilized for a maximum of a two-person load



EN 397
PPE against falls from a height. Industrial safety helmets.



EN 1808
Safety requirements for suspended access equipment



NFPA Class III
defined by NFPA 1983 as being designed to fit around the waist and thighs or under the buttocks and over both shoulders, rated for as maximum of a two-person load and is designed to prevent inverting



EN 564
Mountaineering equipment – Accessory cords



EN 1891
PPE against falls from a height. Low stretch kernmantel ropes.



SINGING ROCK was founded in 1992. During 25 years of its existence, Singing Rock has established itself as a professional and innovative producer and supplier of personal fall protective equipment. Nowadays SINGING ROCK is one of the world leaders on the market of professional protective equipment for work at height, military and rescue. The range of equipment available includes harnesses, ropes, hardware, rappelling devices, safety equipment for heights, anchor points, life lines and sets for typical work situations. All of the high-performance and innovative products are developed and produced in Czech Republic, Europe. The products are certified and fully comply with the international industrial safety standards. Our products are innovative, modern and easy to use, with great strength and with maximum comfort... SINGING ROCK specializes in its production on:

- Development and production of climbing and mountaineering equipment (harnesses, mountaineering ropes, belay and rappel devices carabiners, helmets, ice axes, crampons etc.)
- Development and production of professional equipment for working in height (harnesses, ropes, connectors, anchor devices, lanyards and fall absorbers)
- Methodology and preparation of rope access and secure anchor systems
- Supply or development of suitable safety equipment
- Training services
- Follow-up service – regular product inspection

All activities at Singing Rock run under QMS certification according to ISO 9001 standards with special attention to development, production and sales of Personal Fall Protective Equipment. (Article 11B of Council Directive 89/686/EEC). SINGING ROCK products fulfil appropriate EU directives and standards and requirements of US market (CE, NFPA and ANSI). Singing Rock actively participates in preparation of these standards and directives by its work in the UIAA Safety Commission and CEN working group. SINGING ROCK also cooperates with Czech Standard Organization as an expert in the field of standards for personal protective equipment. SINGING ROCK simply has everything what you need for your Personal Protective Equipment to prevent falling (PPE) and for permanent fall protection.

www.singingrock.com

Warning:

Activities at heights such as climbing, via ferrata, caving, rappelling, ski-touring, rescue, work at height and exploration are dangerous activities, which may lead to severe injury or even death. Thus the following is essential before use: careful reading and understanding of the instructions for use, acquaintance with the possibilities and limitations of the product, adequate apprenticeship in appropriate techniques and methods of use, understanding and acceptance of the risk involved. In case of doubt or problem of understanding, contact SINGING ROCK.



Address:

Singing Rock
Poniklá 317
512 42 Poniklá
Czech Republic

Contact:

tel: +420 481 585 007
e-mail: info@singingrock.com
www.singingrock.com

Social:

 [singingrock.page](#)
 [singingrock_official](#)
 [user/sigrvideo](#)

Catalogue SINGING ROCK 2019 – working equipment
SINGING ROCK – All rights reserved.
Technical specifications may change without notice.

Printed in Czech Republic.



**SAFETY
FIRST**